



Product Catalog

NETZSCH Oil & Gas Upstream

Pumps & Systems

NETZSCH Group Business Unit Pumps & Systems

Since 1873 NETZSCH has been developing and manufacturing instruments and machines for research and industry. Today the group is made up of three global business units:

- Business Unit Analyzing & testing
- Business Unit Grinding & Dispersing
- Business Unit Pumps & Systems

For over five decades we've been supplying worldwide NEMO® progressing cavity pumps, TORNADO® rotary lobe pumps, NOTOS® multiple screw pumps, PERIPRO™ peristaltic pumps, N.Mac® grinders, macerators, metering systems and equipment for custom-built and challenging solutions for your applications. With over 2,500 employees at 6 development and production sites, 50 sales offices, a cooperation partner (in Japan) and another 200 NETZSCH representatives, we are close to you wherever you are. We produce over 50,000 pumps per year with consistent quality in accordance with ISO 9001 standards worldwide and intelligent system integration.

Development, Production and Sales



Europe, Middle East, Africa
NETZSCH Mohnopumpen GmbH
Waldkraiburg, Germany



Central and South America
NETZSCH do Brasil Ltda.
Pomerode, Brazil



Asia Pacific
NETZSCH Lanzhou Pumps
Lanzhou, China



Europe, Middle East, Africa
NETZSCH Oilfield Products GmbH
Selb, Germany



North America
NETZSCH Pumps North America, LLC,
Exton, PA, USA



South Asia
NETZSCH Technologies India Pvt. Limited
Goa, India

We solve unique challenges with our pump solutions

NETZSCH customers are entitled to the best service - we see to that

We are a holistic solutions provider for complex fluid handling. To us, NETZSCH service is of equal importance as the quality of our pumps.

From Planning to Process Monitoring

Consulting, service and quality are our strengths. When buying the pump you have decided on a quality product from NETZSCH for a good reason.

In order to maintain the capacity and quality of your pump, we will support you in all matters, even after the delivery of the pump. Skilled sales and service staff located near your site are at your disposal around the clock.

Process Reliability

NETZSCH service together with quality and genuine parts ensure reliable application of the pump in your operation. Our experience is based on more than 500,000 installed pumps.

Availability

Five production sites guarantee quick supply of parts worldwide.

Quality

Strict quality standards, tests and the certification according to ISO 9001 guarantee all parts are consistently produced with the highest quality.

Your Benefit

- Trained personnel for handling NETZSCH pumps.
- Avoid mistakes with installation and commissioning by one of our many service partners.
- Save costs by preventive maintenance and professional repairs.
- Save time when analyzing damage and restarting pumps.
- Optimize your stock of NETZSCH Genuine Spare Parts.

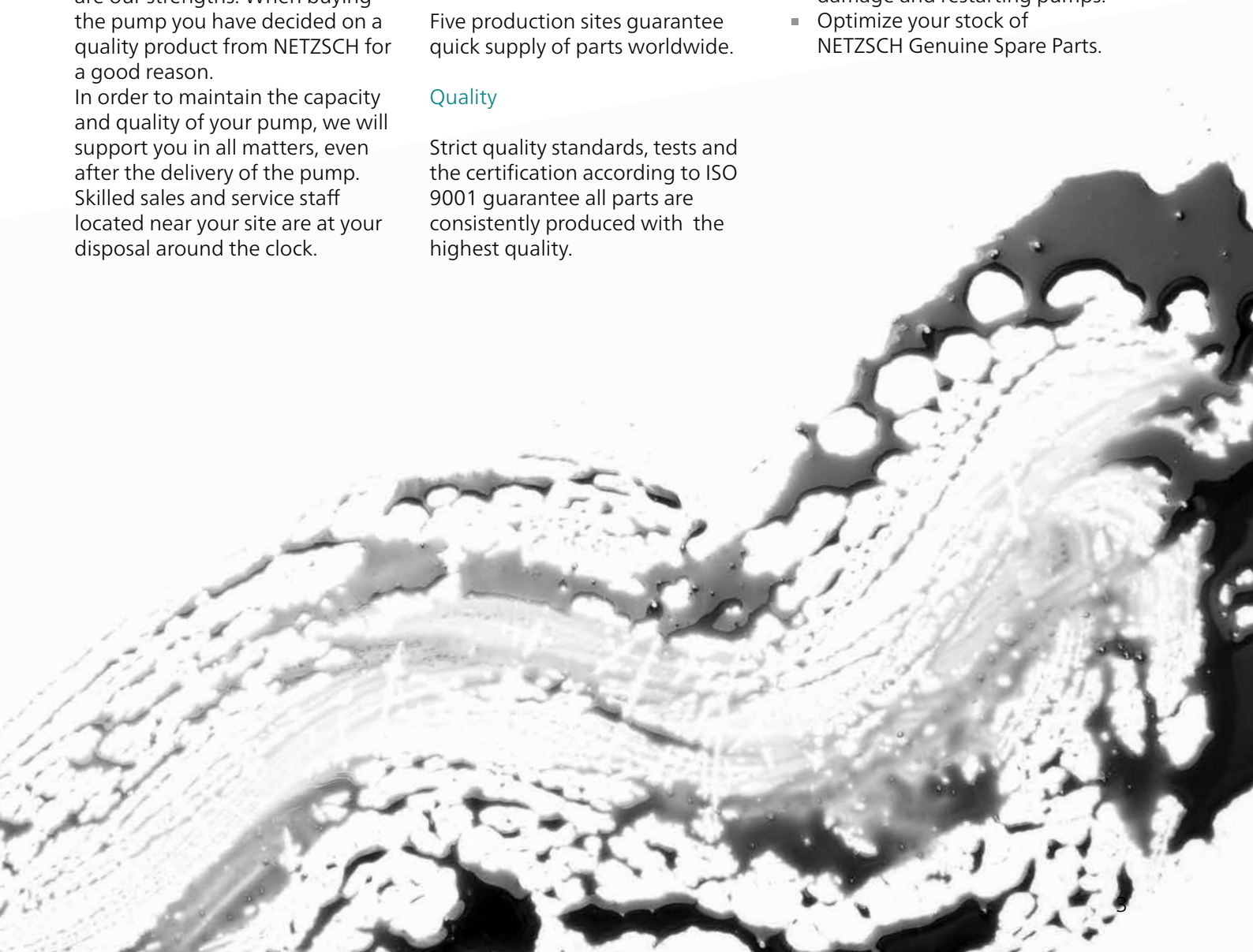

Equipment and Testing

All critical components and products are manufactured in NETZSCH plants – from raw materials to finished products. They are engineered to meet the highest quality standards. Replacement parts are indistinguishable from the originals to provide the integrity of pump performance you expect – with no surprises.

NETZSCH employees and factory-trained representatives provide all engineering and technical support so there are no second guesses. We stand behind our quality so you know you are getting the best possible product to meet the demands of your application.

We use sophisticated machinery for the precise milling of each rotor – no matter what the length – to ensure the best pump performance.



This laboratory focuses on elastomer testing to ensure we deliver stator materials that stand up to the most challenging conditions.



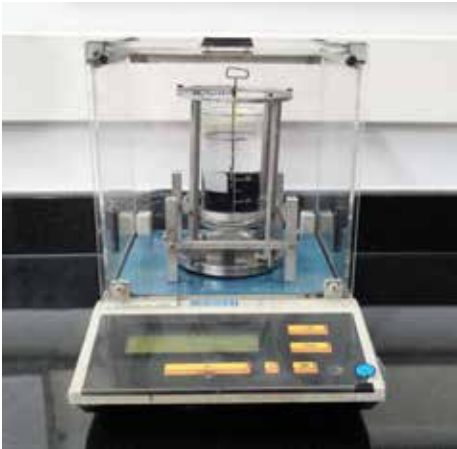

For your assurance, swell testing is offered by NETZSCH but we provide a step by step procedure for you to check the elastomer if you choose.



Precision measuring equipment is used to provide the right tolerances and best fit for pump components.

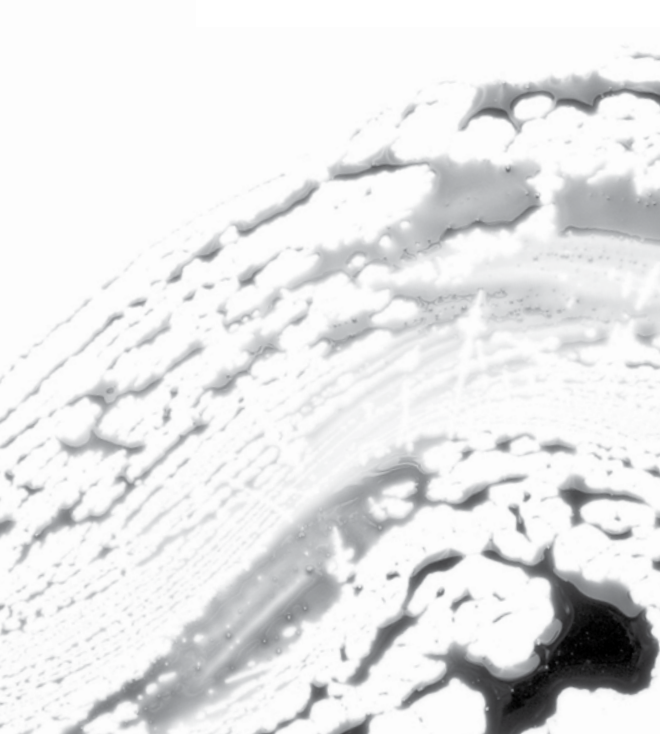

PCP – Pump System

The Progressing Cavity Pump System

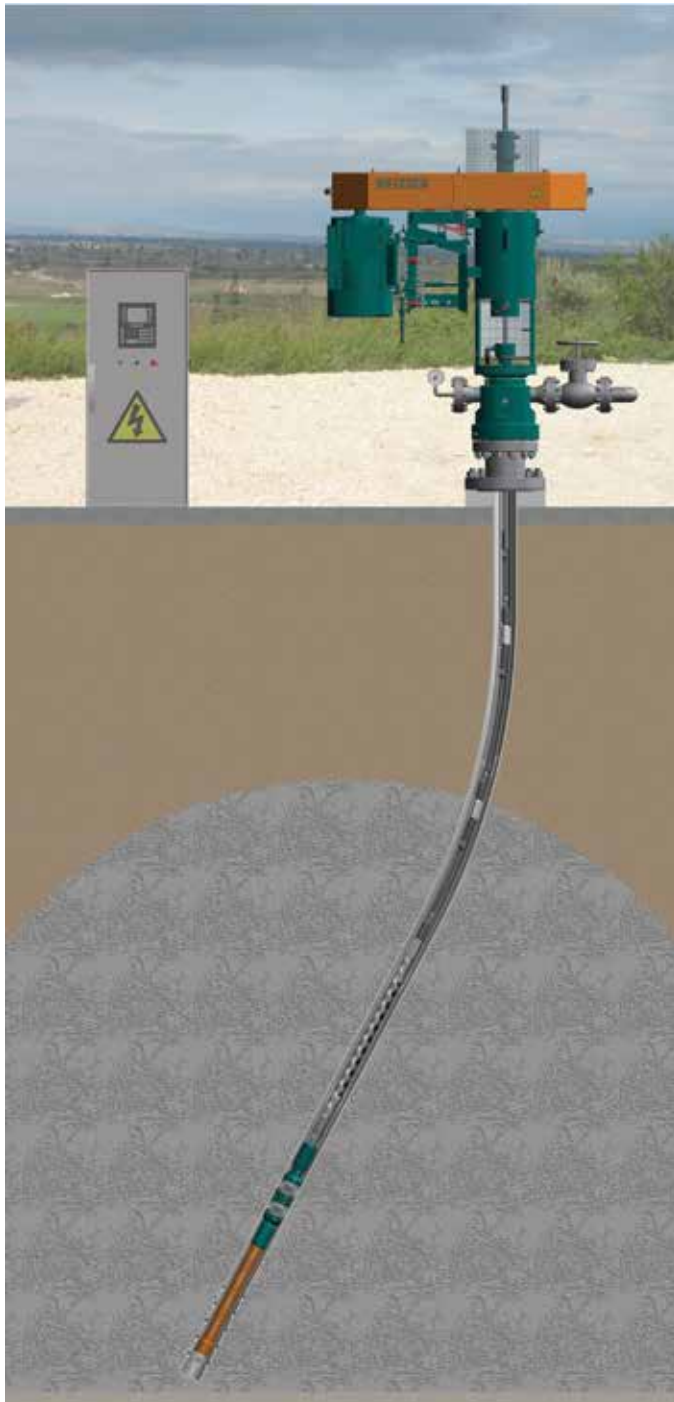

Efficiency

The NETZSCH downhole progressing cavity pump (PCP) systems are simple in structure, have very few moving parts, low hydraulic losses and high efficiency in performance. The overall efficiency is normally between 50% and 85% as compared to 30% efficiency for plunger pumping units and 35% for electrical submerged centrifugal pumps—depending on the API grade.

The typical volumetric efficiency of a NETZSCH downhole PC pump system is 75% – 95% and so provides energy saving advantages.

Compared with other oil extracting equipment, a progressing cavity pump is more suitable to convey crude oil containing high content of solids, high viscosity, high content of water, high content of wax, high content of gas, and the crude mixing multiphases together as well.

NETZSCH Progressing cavity pumps also require less ground equipment, a smaller area for installation, are easy to operate and simple to maintain as compared to plunger oil pumping units and electric submersible pumps (ESP).

These pumps can also satisfy the requirements from the oil wells with different depths. The maximum depth of installation can reach 8,500 ft (2,590 m).

Volumetric Efficiency

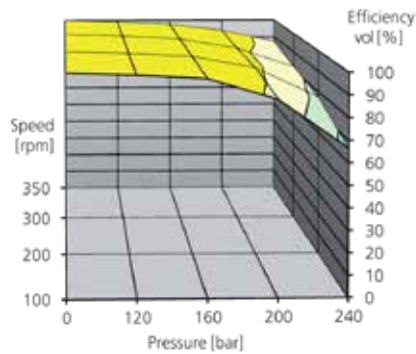

Overall Efficiency

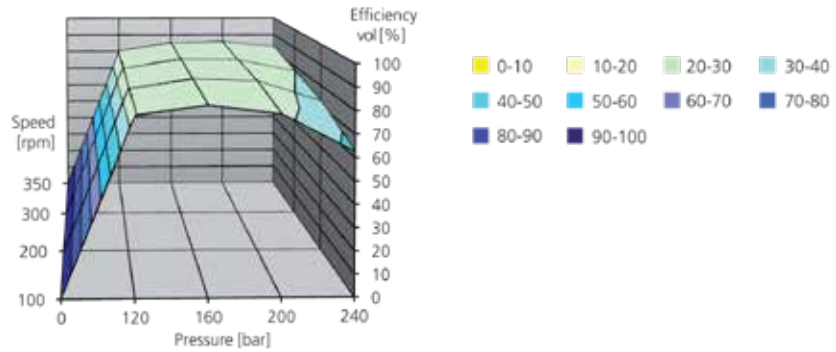

Efficient Handling of Fluid

- High viscosity oil – more than 30,000 cP at the well head
- High sand content – up to 40% at the suction side
- High gas content – app. 40% free gas at the suction side
- Water cut – up to 100%
- Temperature – up to max. 325°F (163°C)
- Pressure – up to 4,500 psi (300 bar)
- Production – up to 126,000 gpd (3,000 bpd) (480 m³/da)

Full Product Range

NETZSCH can also offer progressing cavity pump solutions for the MIDSTREAM and DOWNSTREAM markets. Our strength is our flexibility to design customized solutions for your specific conditions.

Key Advantages

- Low operating cost
- Low investment cost
- Energy saving
- Easy production control



NETZSCH Progressing Cavity Pumps ST Models



ST Pump Model			Pressure †		Rotor		Stator			Tubing		Casing		
NETZSCH Model	m ³ /d (@ 100 rpm)	b/d (@ 100 rpm)	PSI	Bar	rotor length (mm)	Rotor connection for rod size (in) api	stator length (mm)	pump o.d. (mm) with coupling	stop pin length (mm)	stator connection	min ø	max. weight	min ø	max weight
‡ NTZ 166*065 ST0.8	0.8	5.0	943	65	1375	5/8"	1275	77.8	350	1.66" - NU (*A)	1.9"	2.75 lb/ft		
‡ NTZ 166*100 ST0.8			1450	100	1775	5/8"	1675		350					
NTZ 166*120 ST0.8			1740	120	1975	5/8"	1875		350					
‡ NTZ 166*150 ST0.8			2175	150	2650	5/8"	2550		600					
‡ NTZ 166*180 ST0.8			2610	180	2950	5/8"	2850		600					
‡ NTZ 166*200 ST0.8			2900	200	3200	5/8"	3100		600					
NTZ 166*240 ST0.8			3480	240	350	5/8"	3550		600					
‡ NTZ 166*300 ST0.8	4350	300	4375	5/8"	4275	600								
‡ NTZ 166*065 ST1.1	1.1	6.9	943	65	1675	5/8"	1575		350					
‡ NTZ 166*100 ST1.1			1450	100	2235	5/8"	2135		350					
NTZ 166*120 ST1.1			1740	120	2515	5/8"	2415		350					
‡ NTZ 166*150 ST1.1			2175	150	3330	5/8"	3230		600					
‡ NTZ 166*180 ST1.1			2610	180	3750	5/8"	3650		600					
‡ NTZ 166*200 ST1.1			2900	200	4170	5/8"	4070		600					
NTZ 166*240 ST1.1			3480	240	4730	5/8"	4630	600						
‡ NTZ 166*300 ST1.1	4350	300	5715	5/8"	5615	600								
‡ NTZ 238*045 ST1.6	1.6	10.1	653	45	1200	5/8"	1125	350						
NTZ 238*065 ST1.6			943	65	1500	5/8"	1425	350						
NTZ 238*100 ST1.6			1450	100	980	5/8"	1905	350						
NTZ 238*120 ST1.6			1740	120	2220	5/8"	2145	350						
‡ NTZ 238*150 ST1.6			2175	150	2965	5/8"	2890	600						
NTZ 238*165 ST1.6			2393	165	3205	5/8"	3130	600						
‡ NTZ 238*180 ST1.6			2610	180	3325	5/8"	3250	600						
NTZ 238*200 ST1.6			2900	200	3685	5/8"	3610	600						
NTZ 238*240 ST1.6			3480	240	4165	5/8"	4090	600						
NTZ 238*300 ST1.6			4350	300	5140	5/8"	5065	600						
NTZ 238*065 ST3.2	3.2	20.1	943	65	1710	5/8"	1635	350						
NTZ 238*100 ST3.2			1450	100	2302	5/8"	2227	350						
NTZ 238*120 ST3.2			1740	120	2598	5/8"	2523	350						
‡ NTZ 238*150 ST3.2			2175	150	3441	5/8"	3366	600						
NTZ 238*165 ST3.2			2393	165	3737	5/8"	3662	600						
‡ NTZ 238*180 ST3.2			2610	180	3885	5/8"	3810	600						
NTZ 238*200 ST3.2			2900	200	4329	5/8"	4254	600						
NTZ 238*240 ST3.2			3480	240	4921	5/8"	4846	600						
NTZ 238*300 ST3.2	4350	300	6106	5/8"	6031	600								
‡ NTZ 238*030 ST4.0	4.0	25.2	435	30	1300	5/8"	1225	350						
NTZ 238*065 ST4.0			943	65	2100	5/8"	2025	350						
NTZ 238*100 ST4.0			1450	100	2900	5/8"	2825	350						
NTZ 238*120 ST4.0			1740	120	3300	5/8"	3225	350						
‡ NTZ 238*150 ST4.0			175	150	4250	5/8"	4175	600						
‡ NTZ 238*165 ST4.0			2393	165	4550	5/8"	4475	600						
NTZ 238*180 ST4.0			2610	180	4850	5/8"	4775	600						
NTZ 238*200 ST4.0			2900	200	5525	5/8"	5450	600						
NTZ 238*240 ST4.0			3480	240	6325	5/8"	6250	600						
NTZ 238*300 ST4.0			4350	300	7625	5/8"	7550	600						

‡ Not Standard length

†Pumps are available in different pressure stages for different maximum pressures in increments of 300 psi to 450 psi / 20 to 30 bar.

S-Geometry



ST Pump Model		Pressure †		Rotor		Stator			Tubing		Casing			
NETZSCH Model	m ³ /d (@ 100 rpm)	b/d (@ 100 rpm)	PSI	Bar	rotor length (mm)	Rotor connection for rod size (in) api	stator length (mm)	pump o.d. (mm) with coupling	stop pin length (mm)	stator connection	min ø	max. weight	min ø	max weight
NTZ 238*065 ST6.2	6.2	39.0	943	65	2490	5/8"	2415	77.8	350	2.375" - EU	2-3/8"	5.80 lbs/ft	4-1/2"	All API STD
NTZ 238*100 ST6.2			1450	100	3498	5/8"	3423		350					
NTZ 238*120 ST6.2			1740	120	4002	5/8"	3927		350					
‡ NTZ 238*150 ST6.2			2175	150	5134	5/8"	5059		600					
NTZ 238*165 ST6.2			2393	165	5512	5/8"	5437		600					
‡ NTZ 238*180 ST6.2			2610	180	5965	5/8"	5890		600					
NTZ 238*200 ST6.2			2900	200	6721	5/8"	6646		600					
NTZ 238*240 ST6.2			3480	240	7729	5/8"	765		600					
‡ NTZ 238*300 ST6.2	4350	300	9493	5/8"	9418	600								
NTZ 238*050 ST20	20	125.8	725	50	3768	5/8"	3693	77.8	350	2.375" - EU	2-3/8"	5.80 lbs/ft	4-1/2"	All API STD
NTZ 238*100 ST20			1450	100	7011	5/8"	6936		350					
‡ NTZ 238*120 ST20			1740	120	8670	5/8"	8595		350					
NTZ 238*150 ST20			2175	150	10504	5/8"	10429		600					
‡ NTZ 278*060 ST4.0	4.0	25.2	870	60	1895	3/4"	1785	93(EU)/88.9(NU)	350	2.875" - EU/NU	2-3/8" (*B)	5.80 lbs/ft	4-1/2"	15.1 lb/ft (NU) 11.6 lb/ft (EU)
NTZ 278*065 ST4.0			943	65	1985	3/4"	1875		350					
‡ NTZ 278*090 ST4.0			1305	90	2525	3/4"	2415		350					
NTZ 278*100 ST4.0			1450	100	2705	3/4"	2595		350					
NTZ 278*120 ST4.0			1740	120	3065	3/4"	2955		350					
NTZ 278*150 ST4.0			175	150	3945	3/4"	3835		600					
‡ NTZ 278*165 ST4.0			2393	165	425	3/4"	405		600					
NTZ 278*180 ST4.0			2610	180	4485	3/4"	4375		600					
NTZ 278*200 ST4.0			2900	200	5100	3/4"	4990		600					
NTZ 278*240 ST4.0			3480	240	5820	3/4"	5710		600					
‡ NTZ 278*300 ST4.0			4350	300	7065	3/4"	6955		600					
‡ NTZ 278*060 ST7.0			7.0	44.0	870	60	1895		3/4"					
NTZ 278*065 ST7.0	943	65			1985	3/4"	1875	350						
‡ NTZ 278*090 ST7.0	1305	90			2435	3/4"	2325	350						
NTZ 278*100 ST7.0	1450	100			2705	3/4"	2595	350						
NTZ 278*120 ST7.0	1740	120			3070	3/4"	2960	350						
NTZ 278*150 ST7.0	2175	150			3945	3/4"	3835	600						
NTZ 278*165 ST7.0	2393	165			4215	3/4"	4105	600						
NTZ 278*180 ST7.0	2610	180			4485	3/4"	4375	600						
NTZ 278*200 ST7.0	2900	200			5100	3/4"	4990	600						
NTZ 278*240 ST7.0	3480	240			5830	3/4"	5720	600						
‡ NTZ 278*300 ST7.0	4350	300	6995	3/4"	6885	600								
NTZ 278*045 ST10	10	62.9	653	45	1755	7/8"	1645	93(EU)/88.9(NU)	350	2.875" - EU/NU	2-3/8" (*B)	5.80 lbs/ft	4-1/2"	15.1 lb/ft (NU) 11.6 lb/ft (EU)
‡ NTZ 278*060 ST10			870	60	2203	7/8"	2093		350					
NTZ 278*065 ST10			943	65	2315	7/8"	2205		350					
‡ NTZ 278*090 ST10			1305	90	2875	7/8"	2765		350					
NTZ 278*100 ST10			1450	100	3211	7/8"	3101		350					
NTZ 278*120 ST10			1740	120	3659	7/8"	3549		350					
NTZ 278*150 ST10			2175	150	4693	7/8"	4583		600					
‡ NTZ 278*165 ST10			2393	165	5029	7/8"	4919		600					
NTZ 278*180 ST10			2610	180	5365	7/8"	5255		600					
NTZ 278*200 ST10			2900	200	6112	7/8"	6002		600					
NTZ 278*240 ST10			3480	240	7008	7/8"	6898		600					
‡ NTZ 278*300 ST10			4350	300	8464	7/8"	8354		600					

‡ Not Standard length

†Pumps are available in different pressure stages for different maximum pressures in increments of 300 psi to 450 psi / 20 to 30 bar.

NETZSCH Progressing Cavity Pumps ST Models

S-Geometry



ST Pump Model			Pressure †		Rotor		Stator			Tubing		Casing										
NETZSCH Model	m ³ /d (@ 100 rpm)	b/d (@ 100 rpm)	PSI	Bar	rotor length (mm)	Rotor connection for rod size (in) api	stator length (mm)	pump o.d. (mm) with coupling	stop pin length (mm)	stator connection	min ø	max. weight	min ø	max weight								
‡ NTZ 278*045 ST14	14	88.1	653	45	2135	7/8"	2025	93(EU)/88.9(NU)	350	2.875" - EU/NU	2-3/8" (*B)	5.80 lb/ft	4-1/2"	15.1 lb/ft (NU)								
NTZ 278*065 ST14			943	65	2885	7/8"	2775		350													
NTZ 278*100 ST14			1450	100	4085	7/8"	3975		350													
NTZ 278*120 ST14			1740	120	4685	7/8"	4575		350													
NTZ 278*150 ST14			2175	150	5985	7/8"	5875		600													
NTZ 278*165 ST14			2393	165	6660	7/8"	6550		600													
‡ NTZ 278*180 ST14			2610	180	6960	7/8"	6850		600													
NTZ 278*200 ST14			2900	200	7860	7/8"	7750		600													
NTZ 278*240 ST14			3483	240	9060	7/8"	8950		600													
NTZ 278*300 ST14			4350	300	11160	7/8"	11050		600													
NTZ 278*050 ST40	40	251.6	725	50	6201	7/8"	609		350			4.60 lb/ft										
NTZ 278*100 ST40			1450	100	11842	7/8"	1132		350													
‡ NTZ 278*120 ST40H			1740	120	10830	7/8"	10720		350													
NTZ 278*130 ST40H			1885	130	11842	7/8"	11982		350													
NTZ 278*050 ST55	55	345.0	725	50	5515	7/8"	5405		350			5.80 lb/ft		15.1 lb/ft (NU)								
NTZ 278*100 ST55			1450	100	10470	7/8"	10360		350													
NTZ 278*120 ST55H			174	120	10470	7/8"	10360		350													
‡ NTZ 350*060 ST16.4	16.4	103.2	870	60	2770	1"	2625	114.3 (EU) 106 (NU)	350	3.5" - EU/NU	2-7/8" (C*)	7.8 lb/ft	5" (NU) 5.1/2" (EU)	13 lb/ft (NU) 20 lb/ft (EU)								
‡ NTZ 350*065 ST16.4			943	65	2920	1"	2775		350													
‡ NTZ 350*090 ST16.4			1305	90	3670	1"	3525		350													
‡ NTZ 350*100 ST16.4			1450	100	4120	1"	3975		350													
NTZ 350*120 ST16.4			1740	120	4720	1"	4575		350													
NTZ 350*150 ST16.4			2175	150	6020	1"	5875		600													
‡ NTZ 350*165 ST16.4			2393	165	6695	1"	6550		600													
NTZ 350*180 ST16.4			2610	180	7145	1"	7000		600													
‡ NTZ 350*200 ST16.4			2900	200	7895	1"	7750		600													
NTZ 350*240 ST16.4			3480	240	9095	1"	8950		600													
NTZ 350*300 ST16.4			4350	300	11195	1"	11050		600													
‡ NTZ 350*065 ST20			20	125.8	943	65	2910		1"						2765	114.3 (EU) 106 (NU)	350	3.5" - EU/NU	2-7/8" (C*)	7.8 lb/ft	5" (NU) 5.1/2" (EU)	13 lb/ft (NU) 20 lb/ft (EU)
‡ NTZ 350*090 ST20					1305	90	4030		1"						3885		350					
NTZ 350*100 ST20					1450	100	4190		1"						4045		350					
NTZ 350*120 ST20	1740	120			4990	1"	4845	350														
‡ NTZ 350*150 ST20	2175	150			6435	1"	6290	600														
NTZ 350*165 ST20	2393	165			6755	1"	6610	600														
‡ NTZ 350*180 ST20	2610	180			7395	1"	7250	600														
NTZ 350*200 ST20	2900	200			8035	1"	7890	600														
NTZ 350*240 ST20	3480	240			9635	1"	99490	600														
NTZ 350*300 ST20	4350	300			11630	1"	11485	600														
‡ NTZ 350*045 ST25	25	157.2			653	45	2270	1"	2125	114.3 (EU) 106 (NU)	350	3.5" - EU/NU	2-7/8" (C*)	7.8 lb/ft	5" (NU) 5.1/2" (EU)		13 lb/ft (NU) 20 lb/ft (EU)					
NTZ 350*065 ST25					943	65	3070	1"	2925		350											
‡ NTZ 350*090 ST25					1305	90	3870	1"	3725		350											
NTZ 350*100 ST25					1450	100	4350	1"	405		350											
NTZ 350*120 ST25			1740	120	4995	1"	4850	350														
NTZ 350*150 ST25			2175	150	6360	1"	6215	600														
‡ NTZ 350*165 ST25			2393	165	6915	1"	6770	600														
‡ NTZ 350*180 ST25			2610	180	7395	1"	7250	600														
NTZ 350*200 ST25			2900	200	8355	1"	8210	600														
NTZ 350*240 ST25			3480	240	9645	1"	9500	600														
NTZ 350*300 ST25			4350	300	11875	1"	11730	600														
NTZ 350*300 ST25H			4350	300	9645	1"	9500	600														

S-Geometry



ST Pump Model		Pressure †		Rotor		Stator			Tubing		Casing								
NETZSCH Model	m ³ /d (@ 100 rpm)	b/d (@ 100 rpm)	PSI	Bar	rotor length (mm)	Rotor connection for rod size (in) api	stator length (mm)	pump o.d. (mm) with coupling	stop pin length (mm)	stator connection	min ø	max. weight	min ø	max weight					
NTZ 350*045 ST34	34	214	870	60	3170	1"	3025	114.3	350	3.5" - EU/NU	2-7/8" (*C)	7.8 lbs/ft	5" (NU) 5-1/2" (EU)	13 lb/ft (NU) 20 lb/ft (EU)					
NTZ 350*065 ST34			1740	120	5670	1"	5525		350										
NTZ 350*100 ST34			2175	150	7245	1"	7100		600										
NTZ 350*050 ST40	40	251.6	725	50	6236	1"	6091	350											
NTZ 350*100 ST40			1450	100	11877	1"	11732	350											
NTZ 350*050 ST50	50	314.5	435	30	2560	1"	2415	350	114.3 (EU) 106 (NU)		3.5" - EU/NU	6.4 lbs/ft			5" (NU) 5-1/2" (EU)	13 lb/ft (NU) 20 lb/ft (EU)			
NTZ 350*100 ST50			870	60	4180	1"	4035	350											
NTZ 350*120 ST50			2175	150	9980	1-1/8"	9835	600											
NTZ 350*050 ST60	60	377.4	725	50	5150	1-1/8"	5005	350			114.3 (EU) 106 (NU)	3.5" - EU/NU					6.4 lbs/ft	5" (NU) 5-1/2" (EU)	13 lb/ft (NU) 20 lb/ft (EU)
NTZ 350*100 ST60			1450	100	9705	1-1/8"	9560	350											
NTZ 350*035 ST80	80	503.2	508	35	4270	1-1/8"	4125	350		114.3 (EU) 106 (NU)		3-1/2" (*E)	14.3 lb/ft	5" (NU) 5-1/2" (EU)			13 lb/ft (NU) 20 lb/ft (EU)		
NTZ 350*070 ST80			1015	70	7945	1-1/8"	7800	350											
‡ NTZ 350*090 ST80			1305	90	10420	1-1/8"	10275	350											
NTZ 350*100 ST80			1450	100	11620	1-1/8"	11475	350											
‡ NTZ 400*045 ST33			33	207.6	653	45	2670	1"											
NTZ 400*050 ST33	725	50			2870	1"	2725	350											
NTZ 400*060 ST33	870	60			3370	1"	3225	350											
‡ NTZ 400*065 ST33	943	65			3670	1"	3525	350											
‡ NTZ 400*090 ST33	1305	90			4670	1"	4525	350											
NTZ 400*100 ST33	1450	100			5270	1"	5125	350											
‡ NTZ 400*120 ST33	1740	120			6145	1"	6000	350											
NTZ 400*150 ST33	2175	150			7795	1"	7650	600											
‡ NTZ 400*165 ST33	2393	165			8595	1"	8450	600											
‡ NTZ 400*180 ST33	2610	180			8995	1"	8850	600											
NTZ 400*200 ST33	2900	200	10195	1"	10050	600													
‡ NTZ 400*240 ST33	3480	240	11870	1"	11725	600													
‡ NTZ 400*300 ST33H	4350	300	11870	1"	11725	600													
NTZ 400*050 ST40	40	251.6	72	50	3178	1"	3033	350	114.3 (EU) 106 (NU)	4" - NU	3-1/2" (** *F)	14.3 lb/ft	5" (NU) 5-1/2" (EU)	13 lb/ft (NU) 20 lb/ft (EU)					
NTZ 400*060 ST40			870	60	3634	1"	3489	350											
NTZ 400*080 ST40			1160	80	4774	1"	4629	350											
NTZ 400*100 ST40			1450	100	5686	1"	5541	350											
NTZ 400*120 ST40			1740	120	6673	1"	6528	350											
NTZ 400*150 ST40			2175	150	8519	1-1/8"	8374	600											
NTZ 400*160 ST40			2320	160	8975	1-1/8"	8830	600											
NTZ 400*180 ST40			2610	180	10115	1-1/8"	9970	600											
NTZ 400*200 ST40			900	200	11027	1-1/8"	10882	600											
NTZ 400*240 ST40H			3480	240	10115	1-1/8"	9970	600											
‡ NTZ 400*300 ST40H	4350	300	11786	1-1/8"	11641	600													
NTZ 400*030 ST50	50	314.5	435	30	2560	1"	2415	350	114.3 (EU) 106 (NU)	3.5" - EU/NU	2-7/8" (*F)	6.4 lbs/ft	5" (NU) 5-1/2" (EU)	13 lb/ft (NU) 20 lb/ft (EU)					
NTZ 400*060 ST50			870	60	4180	1"	4035	350											
NTZ 400*090 ST50			1305	90	6145	1"	6000	350											
NTZ 400*120 ST50			1740	120	7765	1"	7620	350											
NTZ 400*150 ST50			2175	150	9980	1-1/8"	9835	600											
NTZ 400*180 ST50			2610	180	11600	1-1/8"	11455	600											
NTZ 400*200 ST50H			2900	200	980	1-1/8"	9835	600											
NTZ 400*240 ST50H			3480	240	11600	1-1/8"	11455	600											

‡ Not Standard length

†Pumps are available in different pressure stages for different maximum pressures in increments of 300 psi to 450 psi / 20 to 30 bar.

NETZSCH Progressing Cavity Pumps ST Models



ST Pump Model			Pressure †		Rotor		Stator			Tubing		Casing									
NETZSCH Model	m ³ /d (@ 100 rpm)	b/d (@ 100 rpm)	PSI	Bar	rotor length (mm)	Rotor connection for rod size (in) api	stator length (mm)	pump o.d. (mm) with coupling	stop pin length (mm)	stator connection	min ø	max. weight	min ø	max weight							
NTZ 400*030 ST58	58	364.8	435	30	2770	1"	2625	114.3	350	4" - NU	2-7/8" (*F)	6.4 lb/ft	5-1/2"	20 lb/ft							
NTZ 400*050 ST58			725	50	4270	1"	4125		350												
NTZ 400*060 ST58			870	60	4870	1"	4725		350												
NTZ 400*090 ST58			1305	90	7045	1"	6900		350												
NTZ 400*100 ST58			1450	100	7945	1"	7800		350												
NTZ 400*120 ST58			1740	120	9145	1-1/8"	9000		350												
NTZ 400*150 ST58			2175	150	11570	1-1/8"	11425		600												
NTZ 400*180 ST58			2610	180	3670	1-1/8"	13525		600												
NTZ 400*030 ST62	62	390.0	435	30	2830	1"	2685	350	114.3	4" - NU	2-7/8" (*F)	6.4 lb/ft	5-1/2"	20 lb/ft							
NTZ 400*040 ST62			580	40	3550	1"	3405	350													
NTZ 400*060 ST62			870	60	4990	1"	4845	350													
‡ NTZ 400*075 ST62			1088	75	6145	1"	000	350													
‡ NTZ 400*090 ST62			1305	90	7225	1"	7080	350													
‡ NTZ 400*100 ST62			1450	100	7945	1"	7800	350													
NTZ 400*120 ST62			1740	120	9385	1-1/8"	9240	350													
NTZ 400*150 ST62			2175	150	11870	1-1/8"	11725	600													
NTZ 400*160 ST62H			2320	160	10430	1-1/8"	10285	600													
NTZ 400*180 ST62			2610	180	14030	1-1/8"	13885	600													
NTZ 400*180 ST62H			2610	180	11870	1-1/8"	11725	600													
NTZ 400*200 ST62H			2900	200	14030	1-1/8"	13885	600													
NTZ 400*030 ST78			78	490.6	435	30	2670	1-1/8"			2525	114.3			350	4" - NU	3-1/2" ** (*F)	14.3 lb/ft	5-1/2"	20 lb/ft	
NTZ 400*060 ST78					870	60	5070	1-1/8"			4925										350
NTZ 400*090 ST78	1305	90			7145	1-1/8"	7000	350													
‡ NTZ 400*100 ST78	1450	100			7945	1-1/8"	7800	350													
NTZ 400*120 ST78	1740	120			9545	1-1/8"	9400	350													
‡ NTZ 400*130 ST78	1885	130			10670	1-1/8"	10525	600													
NTZ 400*150 ST78	2175	150			11870	1-1/8"	11725	600													
NTZ 400*150 ST78H	2175	150			9795	1-1/8"	9650	600													
‡ NTZ 400*160 ST78	2320	160			12270	1-1/8"	12125	600													
NTZ 400*180 ST78	2610	180			14270	1-1/8"	14125	600													
NTZ 400*180 ST78H	2610	180			11870	1-1/8"	11725	600													
NTZ 400*200 ST78	2900	200			14270	1-1/8"	14125	600													
‡ NTZ 400*040 ST95	95	597.5			580	40	4245	1-1/8"	4100	114.3	350		4" - NU	3-1/2" ** (*F)			14.3 lb/ft	5-1/2"			20 lb/ft
NTZ 400*065 ST95					943	65	6365	1-1/8"	6220		350										
NTZ 400*080 ST95			1160	80	7895	1-1/8"	7750	350													
NTZ 400*120 ST95			1740	120	1545	1-1/8"	11400	350													
NTZ 400*030 ST120	120	754.8	435	30	4295	1-1/8"	4150	114.3	350	4" - NU	3-1/2" ** (*F)	14.3 lb/ft	5-1/2"	20 lb/ft							
NTZ 400*060 ST120			870	60	995	1-1/8"	7850		350												
NTZ 400*090 ST120			1305	90	11695	1-1/8"	11550		350												
NTZ 400*120 ST120H			1740	120	11695	1-1/8"	1155		350												
NTZ 400*030 ST170	170	1069.2	435	30	4920	1-1/8"	4775	114.3	350	4" - NU	3-1/2" ** (*F)	14.3 lb/ft	5-1/2"	20 lb/ft							
NTZ 400*072 ST170			1044	72	11020	1-1/8"	10875		350												

‡ Not Standard length

†Pumps are available in different pressure stages for different maximum pressures in increments of 300 psi to 450 psi / 20 to 30 bar.

S-Geometry



ST Pump Model			Pressure †		Rotor		Stator			Tubing		Casing		
NETZSCH Model	m ³ /d (@ 100 rpm)	b/d (@ 100 rpm)	PSI	Bar	rotor length (mm)	Rotor connection for rod size (in) api	stator length (mm)	pump o.d. (mm) with coupling	stop pin length (mm)	stator connection	min ø	max. weight	min ø	max weight
‡ NTZ 450*120 ST40.2	40.2	252.8	1740	120	5550	1-1/8"	5355	141.3	350	4.5" EU	4" (*G)	11 lb/ft	6-5/8"	28 lb/ft
‡ NTZ 450*150 ST40.2			2175	150	8635	1-1/8"	8440		600					
NTZ 450*050 ST80	80	503.2	725	50	4230	1-1/8"	4085	132.0	350	4.5" NU	3.5" (*G)	7.7 lb/ft	6-5/8"	32 lb/ft
NTZ 450*100 ST80			1450	100	7865	1-1/8"	7720		350					
NTZ 450*150 ST80			2175	150	11750	1-1/8"	11605		600					
NTZ 450*060 ST101	101	635.0	870	60	4220	1-1/8"	3025	141.3	350	4.5" EU	3.5" (*G)	9.2 lb/ft	8"	44 lb/ft
NTZ 450*120 ST101			1740	120	7795	1-1/8"	5525		350					
NTZ 450*180 ST101			2610	180	11620	1-1/8"	7100		600					
NTZ 450*075 ST120	120	754.8	1088	75	5710	1-1/8"	5665	141.3	350	4.5" EU	3.5" (*G)	7.7 lb/ft	6-5/8"	28 lb/ft
NTZ 450*150 ST120			2175	150	11075	1-1/8"	10930		600					
NTZ 450*050 ST160	160	1006.4	725	50	5070	1-1/8"	4925	141.3	350	5" LTC	3.5" (*G)	11 lb/ft	6-5/8"	28 lb/ft
NTZ 450*100 ST160			1450	100	9545	1-1/8"	9400		350					
NTZ 500*080 ST100	100	629.0	1160	80	4864	1-1/8"	4669	141.3	350	5" LTC	3.5" (*G)	11 lb/ft	6-5/8"	28 lb/ft
NTZ 500*160 ST100			2320	160	9333	1-1/8"	9138		600					
NTZ 500*030 ST280	280	1761.1	435	30	4820	1-1/8"	4625	141.3	350	5" LTC	3.5" (*G)	16.1 lb/ft	6-5/8"	28 lb/ft
NTZ 500*078 ST280			1131	78	11530	1-1/8"	11335		350					
‡ NTZ 550*065 ST98	98	616.4	943	65	4080	1-1/8"	3885	153.7	350	5.5" LTC/BTC	4-1/5" (*1)	17 lb/ft	7"	26 lb/ft
‡ NTZ 550*100 ST98			1450	100	6015	1-1/8"	5820		350					
NTZ 550*130 ST98	98	616.4	1885	130	7765	1-1/8"	7570	153.7	600	5.5" LTC/BTC	4-1/5" (*1)	17 lb/ft	7"	26 lb/ft
‡ NTZ 550*150 ST98			2175	150	8800	1-1/8"	8605		600					
NTZ 550*195 ST98			2828	195	11200	1-1/8"	11005		600					
‡ NTZ 550*210 ST98	98	616.4	3045	210	11875	1-1/8"	11680	153.7	600	5.5" LTC/BTC	4-1/5" (*1)	17 lb/ft	7"	26 lb/ft
‡ NTZ 550*220 ST98			3190	220	12475	1-1/8"	12280		600					
NTZ 550*030 ST128	128	805.1	435	30	2592	1-1/8"	2397	153.7	350	5.5" LTC/BTC	4-1/5" (*1)	17 lb/ft	7"	26 lb/ft
NTZ 550*060 ST128			870	60	4464	1-1/8"	4269		350					
NTZ 550*090 ST128			1305	90	6411	1-1/8"	6216		350					
NTZ 550*120 ST128			1740	120	8283	1-1/8"	8088		350					
NTZ 550*150 ST128			2175	150	10480	1-1/8"	10285		600					
NTZ 550*180 ST128H			2610	180	10480	1-1/8"	10285		600					
‡ NTZ 550*200 ST128H			2900	200	11416	1-1/8"	11221		600					
NTZ 550*050 ST145	145	912.0	725	50	4320	1-1/8"	4125	153.7	350	5.5" LTC/BTC	4-1/5" (*1)	17 lb/ft	7"	26 lb/ft
NTZ 550*100 ST145			450	100	7995	1-1/8"	7800		350					
NTZ 550*150 ST145			2175	150	11920	1-1/8"	11725		600					
NTZ 550*180 ST145H			2610	180	11920	1-1/8"	11725		600					
NTZ 550*030 ST176	176	1107.0	435	30	2820	1-1/8"	2625	153.7	350	5.5" LTC/BTC	4-1/5" (*1)	17 lb/ft	7"	26 lb/ft
NTZ 550*060 ST176			70	60	4920	1-1/8"	4725		350					
NTZ 550*120 ST176			1740	120	9195	1-1/8"	9000		350					
NTZ 550*150 ST176			2175	150	11620	1-1/8"	11425		600					
NTZ 550*050 ST200	200	1257.9	725	50	4624	1-1/8"	4429	153.7	350	5.5" LTC/BTC	4-1/5" (*1)	17 lb/ft	7"	26 lb/ft
NTZ 550*100 ST200			1450	100	8603	1-1/8"	8408		350					
‡ NTZ 550*135 ST200			1958	135	11856	1-1/8"	11661		600					

‡ Not Standard length

†Pumps are available in different pressure stages for different maximum pressures in increments of 300 psi to 450 psi / 20 to 30 bar.

NETZSCH Progressing Cavity Pumps ST Models



ST Pump Model			Pressure †		Rotor		Stator			Tubing		Casing		
NETZSCH Model	m ³ /d (@ 100 rpm)	b/d (@ 100 rpm)	PSI	Bar	rotor length (mm)	Rotor connection for rod size (in) api	stator length (mm)	pump o.d. (mm) with coupling	stop pin length (mm)	stator connection	min ø	max. weight	min ø	max weight
NTZ 658*080 ST200	200	1257.9	1160	80	5620	1-1/8"	5425	187.7	350	6.625" BTC	5-1/2" (*J)	23 lb/ft	8-5/8"	44 lb/ft
NTZ 658*120 ST200			2320	160	10845	1-1/8"	10650		600					
NTZ 658*036 ST330	330	2075.6	522	36	3715	1-1/8"	3520	187.7	350	6.625" BTC	5-1/2" (*J)	23 lb/ft	8-5/8"	44 lb/ft
NTZ 658*072 ST330			1044	72	6785	1-1/8"	6590		350					
NTZ 658*108 ST330			1566	108	9855	1-1/8"	9660		350					

‡ Not Standard length

** For Smaller tubing, consult engineering

(*A) Upper connection 2.375 EU (F) first tubing above pump must be 2-3/8"

(*B) The first tubing above the pump must be 2-7/8"

(*C) The first tubing above the pump must be 3-1/2"

(*D) The first tubing above the pump must be 7.7 lb/ft (max.)

(*E) The first tubing above the pump must be 10.2 lb/ft (max.)

(*F) The first tubing above the pump must be 4"

(*G) The first tubing above the pump must be 4-1/2"

(*H) The first tubing above the pump must be 5"

(*I) The first tubing above the pump must be 5-1/2"

(*J) The first tubing above the pump must be 6-5/8"

†Pumps are available in different pressure stages for different maximum pressures in increments of 300 psi to 450 psi / 20 to 30 bar.

NETZSCH Progressing Cavity Pumps DT Models

D-Geometry



DT Pump Model		Pressure †		Rotor		Stator				
NETZSCH Model	m ³ /d (@ 100 rpm)	b/d (@ 100 rpm)	PSI	Bar	rotor length (mm)	Rotor connection for rod size (in) api	Stator length (mm)	pump o.d. (mm) with coupling	Stop pin length (mm)	Stator connection
‡ NTZ 238*060 DT14	14.0	88	870	60	1920	5/8"	1860	66.0	350	2.375" - EU
‡ NTZ 238*120 DT14			1800	120	3775	5/8"	3720		350	
‡ NTZ 238*150 DT14			2200	150	4820	5/8"	4765		600	
‡ NTZ 238*180 DT14			2600	180	5615	5/8"	5560		600	
‡ NTZ 238*200 DT14			2900	200	3660	5/8"	6275		600	
‡ NTZ 238*240 DT14			3500	240	7280	5/8"	7225		600	
‡ NTZ 278*060 DT16	16.0	100	870	60	1910	7/8"	1750	78.6	350	2.875" - EU
‡ NTZ 278*090 DT16			1300	90	2547	7/8"	2387		350	
‡ NTZ 278*120 DT16			1800	120	3195	7/8"	3090		350	
‡ NTZ 278*150 DT16			2200	150	4083	7/8"	3978		600	
‡ NTZ 278*180 DT16			2600	180	4720	7/8"	4615		600	
‡ NTZ 278*200 DT16			2900	200	5304	7/8"	5199		600	
‡ NTZ 278*240 DT16	3500	240	6070	7/8"	5965	600				
‡ NTZ 278*090 DT20	20.0	126	1300	90	3020	7/8"	2860	78.6	350	2.875" - EU
‡ NTZ 278*120 DT20			1800	120	3825	7/8"	3720		350	
‡ NTZ 278*150 DT20			2200	150	4945	7/8"	4840		600	
‡ NTZ 278*180 DT20			2600	180	5740	7/8"	5635		600	
‡ NTZ 278*200 DT20			2900	200	6376	7/8"	6271		600	
‡ NTZ 278*240 DT20			3500	240	7330	7/8"	7225		600	
‡ NTZ 278*060 DT25	25.0	157	870	60	2615	7/8"	2450	78.6	350	2.875" - EU
‡ NTZ 278*090 DT25			1300	90	3605	7/8"	3450		350	
‡ NTZ 278*100 DT25			1500	100	4010	7/8"	3850		350	
‡ NTZ 278*120 DT25			1800	120	4605	7/8"	4500		350	
‡ NTZ 278*150 DT25			2200	150	5920	7/8"	5815		600	
‡ NTZ 278*180 DT25			2600	180	6910	7/8"	6805		600	
‡ NTZ 278*200 DT25			2900	200	7720	7/8"	7615		600	
‡ NTZ 278*240 DT25			3500	240	8890	7/8"	8785		600	
‡ NTZ 278*048 DT32	32.0	200	700	48	2930	7/8"	2770	95.2	350	2.875" - EU
‡ NTZ 278*060 DT32			870	60	3185	7/8"	3025		350	
‡ NTZ 278*090 DT32			1300	90	4460	7/8"	4300		350	
‡ NTZ 278*120 DT32			1800	120	5820	7/8"	5715		350	
‡ NTZ 278*150 DT32			2200	150	7345	7/8"	7240		600	
‡ NTZ 278*180 DT32			2600	180	8620	7/8"	8515		600	
‡ NTZ 278*200 DT32			2900	200	9640	7/8"	9535		600	
‡ NTZ 278*240 DT32			3500	240	11250	7/8"	11110		600	
‡ NTZ 350*060 DT33	33.0	208	870	60	2320	1"	2125	95.2	350	3.50" - EU
‡ NTZ 350*090 DT33			1300	90	3155	1"	3015		350	
‡ NTZ 350*100 DT33			1500	100	3475	1"	3280		350	
‡ NTZ 350*120 DT33			1800	120	3980	1"	3840		350	
‡ NTZ 350*150 DT33			2200	150	5055	1"	4915		600	
‡ NTZ 350*180 DT33			2600	180	5955	1"	5815		600	
‡ NTZ 350*200 DT33			2400	200	6615	1"	6475		600	
‡ NTZ 350*240 DT33			3500	240	7605	1-1/8"	7465		600	
‡ NTZ 350*300 DT33			4400	300	9255	1-1/8"	9115		600	

‡ Not Standard length

NETZSCH Progressing Cavity Pumps DT Models

D-Geometry



DT Pump Model		Pressure †		Rotor		Stator				
NETZSCH Model	m ³ /d (@ 100 rpm)	b/d (@ 100 rpm)	PSI	Bar	rotor length (mm)	Rotor connection for rod size (in) api	Stator length (mm)	pump o.d. (mm) with coupling	Stop pin length (mm)	Stator connection
‡ NTZ 350*100 DT40	40.0	250	1500	100	4100	1"	3960	95.2	350	3.5" - EU
‡ NTZ 350*120 DT40			1800	120	4945	1"	4750		350	
NTZ 350*150 DT40			2200	150	6305	1"	6160		600	
‡ NTZ 350*200 DT40			2900	200	7835	1"	7690		600	
NTZ 350*120 DT40			1800	120	3440	1"	3311		350	
NTZ 350*160 DT40			2320	160	4340	1"	4210		600	
NTZ 350*240 DT40			3500	240	6035	1-1/8"	5906		600	
NTZ 350*320 DT40			4640	320	7835	1-1/8"	7705		600	
‡ NTZ 400*060 DT50	50.0	315	870	60	2710	1"	2515	101.6	350	4" - NU
‡ NTZ 400*090 DT50			1300	90	3730	1"	3600		350	
NTZ 400*100 DT50			1500	100	4138	1"	3945		350	
‡ NTZ 400*120 DT50			1800	120	4790	1"	4630		350	
‡ NTZ 400*150 DT50			2200	150	6125	1"	5965		600	
NTZ 400*180 DT50			2600	180	7155	1-1/8"	6995		600	
NTZ 400*200 DT50			2900	200	7961	1-1/8"	7801		600	
NTZ 400*240 DT50			3500	240	9205	1-1/8"	9045		600	
NTZ 278*75 DT55	55.0	346	1087.5	75	5230	1"	5085	93	350	2.875" - EU
NTZ 278*120 DT55			1740	120	8345	1"	8150		350	
NTZ 278*150 DT55			2175	150	10115	1"	9970		600	
NTZ 278*180 DT55H			2610	180	10115	1"	9970		600	
NTZ 400*060 DT66	66.0	415	870	60	3340	1"	3145	101.6	350	4" - NU
NTZ 400*90 DT66			1300	90	4715	1"	4555		350	
NTZ 400*100 DT66			1500	100	5209	1"	5015		350	
NTZ 400*120 DT66			1800	120	6115	1"	5955		350	
NTZ 400*150 DT66			2200	150	7710	1-1/8"	7550		600	
‡ NTZ 400*180 DT66			2600	180	9905	1-1/8"	8895		600	
NTZ 400*200 DT66			2900	200	10103	1-1/8"	9943		600	
‡ NTZ 400*240 DT66			3500	240	11800	1-1/8"	11640		600	
NTZ 400*080 DT83	83.0	522	1160	80	5087	1"	4892	101.6	350	4" - NU
NTZ 400*090 DT83			1300	90	5830	1"	5635		350	
NTZ 400*100 DT83			1500	100	6538	1"	6378		350	
NTZ 400*120 DT83			1800	120	7555	1"	7395		350	
NTZ 400*150 DT83			2200	150	9370	1-1/8"	9225		600	
NTZ 400*180 DT83			2600	180	11224	1-1/8"	11095		600	
NTZ 400*200 DT83			2900	200	11918	1-1/8"	11770		600	
NTU 400*070 DT83			1010	70	4090	1-1/8"	3930		350	
NTU 400*100 DT83			1500	100	5117	1-1/8"	4957		350	
NTU 400*130 DT83			1900	130	6788	1-1/8"	6628		600	
NTZ 400*150 DT83			2200	150	9400	1-1/8"	9240		600	
NTU 400*170 DT83			2500	170	7805	1-1/8"	7645		600	
NTU 400*200 DT83			2900	200	8832	1-1/8"	8672		600	
NTZ 400*060 DT110			110.0	692	870	60	5170		1-1/8"	
NTZ 400*090 DT110	1300	90			7525	1-1/8"	7365	350		
NTZ 400*120 DT110	1800	120			9775	1-1/8"	9615	350		
NTZ 400*150 DT110	2200	150			11920	1-1/8"	11760	600		
‡ NTZ 400*060 DT142	142.0	893	870	60	6995	1-1/8"	6400	101.6	350	4" - NU
NTZ 400*090 DT142			1300	90	9530	1-1/8"	9370		350	
‡ NTZ 400*120 DT142			1800	120	12545	1-1/8"	12385		350	

‡ Not Standard length

D-Geometry



DT Pump Model			Pressure †		Rotor		Stator			
NETZSCH Model	m ³ /d (@ 100 rpm)	b/d (@ 100 rpm)	PSI	Bar	rotor length (mm)	Rotor connection for rod size (in) api	Stator length (mm)	pump o.d. (mm) with coupling	Stop pin length (mm)	Stator connection
† NTZ 450*090 DT74	74.0	465	1300	90	3580	1-1/8"	3690	122.0	350	4.5" - NU
NTZ 450*120 DT74			1800	120	4900	1-1/8"	4740		350	
NTZ 450*150 DT74			2200	150	6275	1-1/8"	6115		600	
NTZ 450*180 DT74			2600	180	7325	1-1/8"	7165		600	
NTZ 450*200 DT74			2900	200	8165	1-1/8"	8005		600	
NTZ 450*240 DT74			3500	240	9425	1-1/8"	9265		600	
† NTZ 450*090 DT150	150	943	1300	90	7085	1-1/8"	6925	122.0	350	4.5" - NU
NTZ 450*120 DT150			1800	120	9185		9025		350	
NTZ 450*150 DT150			2200	150	11615		11455		600	
† NTZ 500*090 DT138	138	868	1300	90	5220	1-1/8"	5040	127.0	350	5" - LTC
NTZ 500*120 DT138			1800	120	6795		6615		350	
NTZ 500*150 DT138			2200	150	8545		8365		600	
NTZ 500*180 DT138			2600	180	10045		9865		600	
† NTZ 500*200 DT138			2900	200	11320		11140		600	
† NTZ 500*100 DT170	170	1069	1500	100	6915	1-1/8"	6735	127.0	350	5" - LTC
† NTZ 500*120 DT170			1800	120	7945		7750		350	
† NTZ 500*150 DT170			2200	150	10405		10225		600	
† NTZ 500*180 DT170			2600	180	11920		11740		600	
† NTZ 500*090 DT226	226	1421	1300	90	8845	1-1/8"	8665	127.0	350	5" - LTC
† NTZ 500*120 DT226			1800	120	10885		10705		350	

‡ Not Standard length

†Pumps are available in different pressure stages for different maximum pressures in increments of 300 psi to 450 psi / 20 to 30 bar.

PC Pump Nomenclature

NTZ BBB*CCC DD E

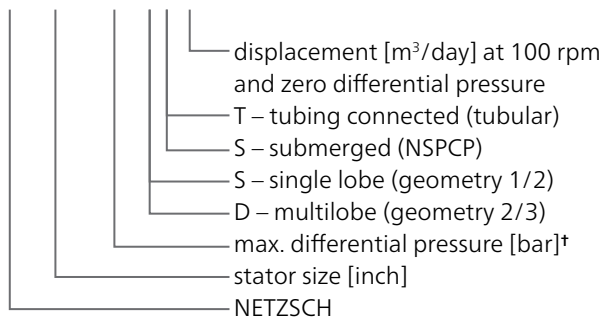

Pump Equipment

NTU Progressing Cavity Pumps

Produced with steel tube conformed with the same internal geometry as the stator (helical). Thus the elastomer has a uniform wall and produces even distribution of the elastomer. The main NTU pump feature is its lower operation and starting torque due to its lower swelling when exposed to temperature variations and chemically aggressive fluids.

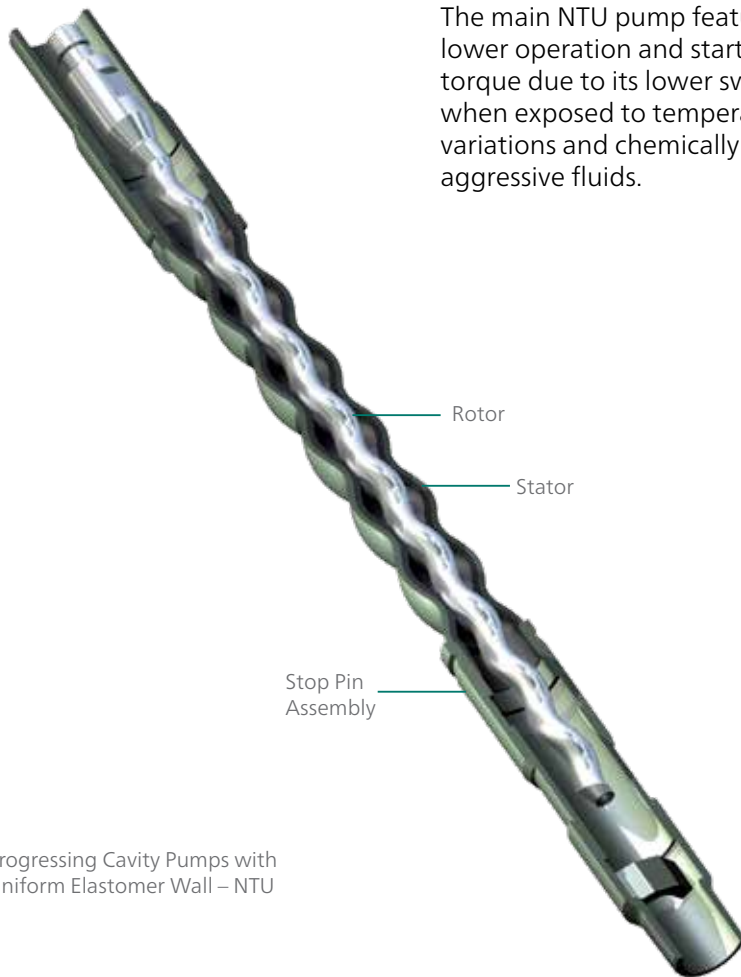

Progressing Cavity Pumps with Uniform Elastomer Wall – NTU

Advantages

- Ideal for highly aggressive chemical fluids.
- Higher run life in applications with critical conditions.
- Higher mechanical efficiency of the system.
- Lower starting torque.
- Lower swelling.
- Lower dimensional variation due to temperature and chemical attack.
- Shorter pump length.
- Higher pressure capacity per stage.
- Reduction of rod parting.
- Easy installation and transport.
- Lower operational torque.
- Molded in tube with uniform wall guarantee.
- Easier to assemble in wells with deviations.
- Lower hysteresis.
- Better heat dissipation.

The difference between NTZ and NTU geometries

The NTU pump features less rubber volume in relation to the NTZ pump (already on the market) which results in less swelling when used for pumping a highly aggressive fluid.



NTU-DT Geometry



NTZ-DT Geometry



NTU-ST Geometry



NTZ-ST Geometry

NTU Progressing Cavity Pump

pump model	production rate		max. differential pressure		rotor			stator
	m ³ /d/ 100 rpm	bpd	bar	psi	thread T1	diameter D1	length L1	length L2
					in	mm	mm	mm
Model 2-7/8"								
NTU 278*100ST10	10	63	100	1,450	7/8"	41.3	2,005	1,911
NTU 278*150ST10	10	63	150	2,175	7/8"	41.3	2,565	2,472
NTU 278*200ST10	10	63	200	2,900	7/8"	41.3	3,200	3,105
NTU 278*230ST10	10	63	230	3,335	7/8"	41.3	3,461	3,367
NTU 278*270ST10	10	63	270	3,915	7/8"	41.3	3,909	3,815

stator diameter D2: 93 mm; stator thread T2: 2-7/8" EU box
min. tubing: 2-3/8"; min. casing: 4-1/2"; all pump models are also available with NU thread

Model 3 1/2"								
NTU 350*120DT40	40	252	120	1,740	1"	54	3,440	3,311
NTU 350*160DT40	40	252	160	2,320	1"	54	4,340	4,210
NTU 350*240DT40	40	252	240	3,480	1-1/8"	58	6,035	5,906
NTU 350*320DT40	40	252	320	4,641	1-1/8"	58	7,835	7,705

stator diameter D2: 114.3 mm; stator thread T2: 3-1/2" EU box
min. tubing: 2-7/8"; min. casing: 5-1/2"; all pump models are also available with NU thread

Model 4"								
NTU 400*070DT83	83	522	70	1050	1"	58	3,293	3,163
NTU 400*100DT83	83	522	100	1450	1"	58	4,310	4,180
NTU 400*130DT83	83	522	130	1885	1-1/8"	58	5,337	5,207
NTU 400*170DT83	83	522	170	2465	1-1/8"	58	6,785	6,628
NTU 400*200DT83	83	522	200	2900	1-1/8"	58	7,775	7,645

stator diameter D2: 125 mm; stator thread T2: 4" EU box
min. tubing: 2-7/8"; min. casing: 5-1/2"; all pump models are also available with NU thread

Model 5"								
NTU 500*110ST98	98	616	110	1,595	1-1/8"	88.9	4,330	4,151
NTU 500*220ST98	98	616	220	3,190	1-1/8"	88.9	7,765	7,586

stator diameter D2: 141.3 mm; stator thread T2: 5" LTC box
min. tubing: 4-1/2"; min. casing: 6-5/8"; all pump models are also available with NU thread

Insertable Progressing Cavity Pump

Solutions for Cost Economy with Rigs and Production Cost

Insertable Progressing Cavity Pump

NETZSCH specializes in the delivery of insertable progressing cavity pumps for the production of crude oil and other highly viscous materials; PCP pumps are used throughout the world. Whether it is a large oilfield operator or a small production company, the use of innovative pump technologies from NETZSCH offers safe and reliable production processes at low life cycle costs.

Applications

The main feature of Insertable Progressing Cavity Pumps (rotor & stator) is their assembly inside the tubing. Thus, the pump is not connected to the production line but assembled inside it.

- Wells with low flow — the cost of the intervention makes the use of a normal pump economically unsuitable.
- Wells with a high frequency of interventions (independent of the flow).
- Flow range 1.3 to 491 bpd at 100 rpm.
- Pressure range 1,450 psi to 3,480 psi / 100 to 240 bar.
- Pump with downhole sensors.

Key Advantages

- Minimization of the time of intervention.
- Minimization of costs of rig.
- Minimize rig costs in workover services, this minimizes production losses.
- Pump substitution without removing it from the tubing.
- Pump substitution with flush-by equipment.
- Up to 60% savings in pump replacement.
- Does not require removal of downhole sensors and cable.

Nomenclature of the NETZSCH Insertable Pump

NTZ BBB CCC D E F GG

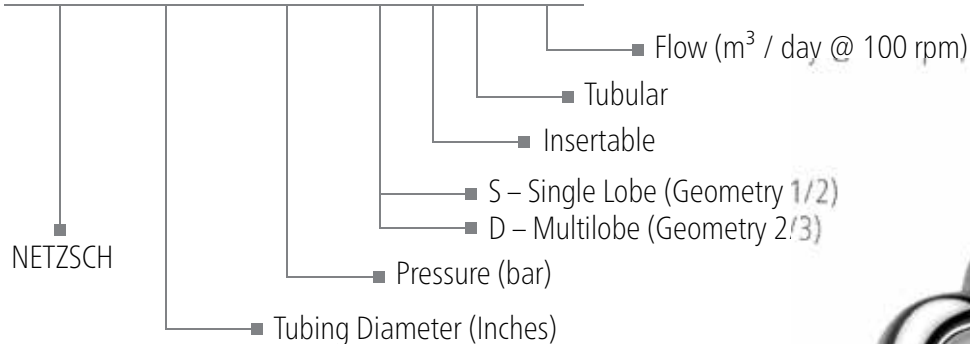

Insertable PCP Pump Types

Make the Right Choice for the Right Application

Tubing Production	Geometry	Displacement at 100 rpm		Production Tubing Size	Drift (mm)	Drift (in)	Seating Type		
		m ³ /day	bpd				NETZSCH	N11 top	N11 bottom
238	SIT	0.8	5.0	2.3/8" x 5.8 lb/ft	45.04	1.773	•		
	SIT	1.1	6.9				•		
	DIT	4.6	28.9				•		
278	SIT	1.6	10.1	2-7/8" x 6.4 lb/ft	59.61	2.347	•		•
	SIT	3.2	20.1				•		•
	SIT	4.0	25.2				•		•
	SIT	6.4	40.3				•		•
	SIT	11	69.2				•		•
350	DIT	14.6	91.8	3-1/2" x 9.2 lb/ft	72.82	2.867	•		•
	SIT	20	125.8				•		•
	SIT	4.0	25.2				•	•	
	SIT	6.4	40.3				•	•	
	SIT	11	69.2				•	•	
	DIT	14.6	91.8				•	•	
	SIT	20	125.8				•	•	
	DIT	32	201.3						•
	SIT	40	251.6						•
	SIT	5	345.9						•
450	SIT	14	88.1	4-1/2" x 12.6 lb/ft	97.36	3.833	•	•	
	SIT	16.4	103.2				•	•	
	SIT	25	157.2				•	•	
	SIT	33	207.6					•	
	SIT	40	2,516					•	
	SIT	50	314.5					•	
	SIT	60	377.4				•	•	
	SIT	62	390.0					•	
	DIT	83	522.1				•	•	
550	SIT	16.4	103.2	5-1/2" x 15.5 lb/ft	122.56	4.825	•	•	
	SIT	25	157.2				•	•	
	SIT	33	207.6				•	•	
	SIT	40	251.6				•	•	
	SIT	50	314.5					•	
	SIT	62	390.0				•	•	
	SIT	78	490.6				•	•	
	DIT	83	522.1				•	•	

Special Pumps AND SPECIAL PUMP SYSTEM

NETZSCH offers special PCP pumps for the oil industry that are characterized by a robust and reliable design. Construction and materials are adapted to the requirements. Together with the customer's requirements are specified in the planning phase and the optimal pump is selected.

Nipple N11 System

Key Advantage

Interchangeable with insert sucker rod pump in N11 seating nipple

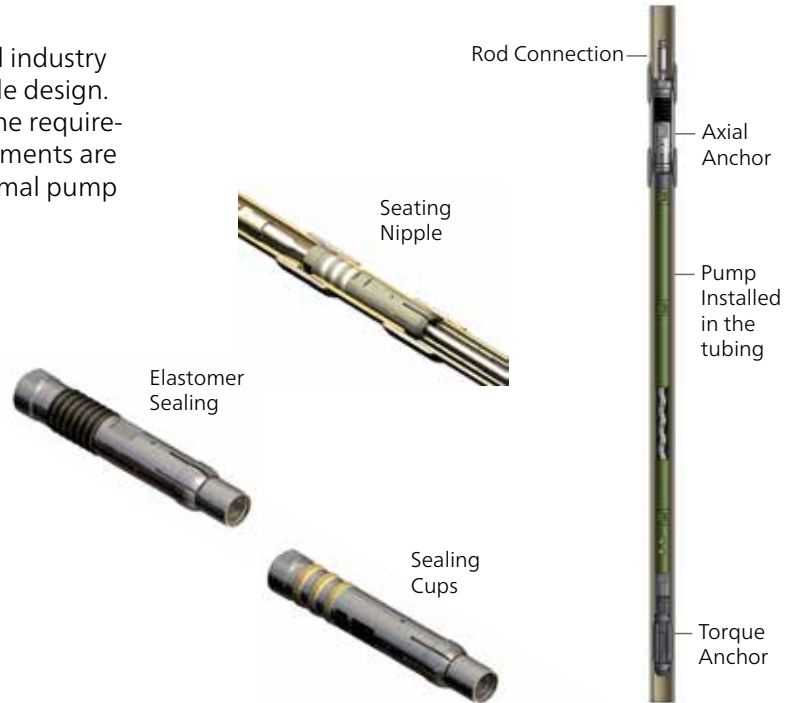

Nipple NETZSCH System

Nipple NETZSCH System
Insertable Progressing Cavity
Pump design

Anchoring Set

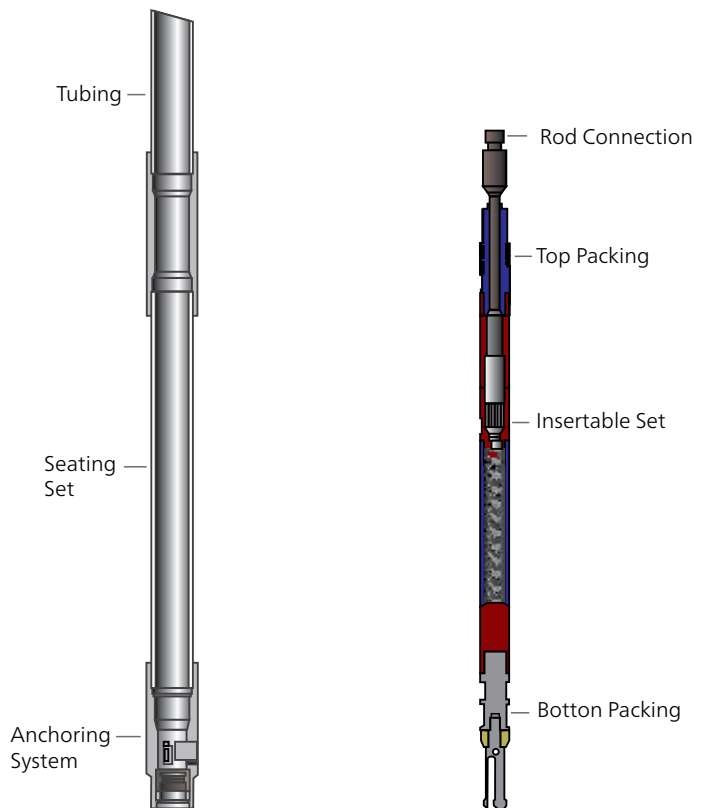

Insertable Systems

Parts, Assembly and Disassembly Procedure

For Nipple N11 System

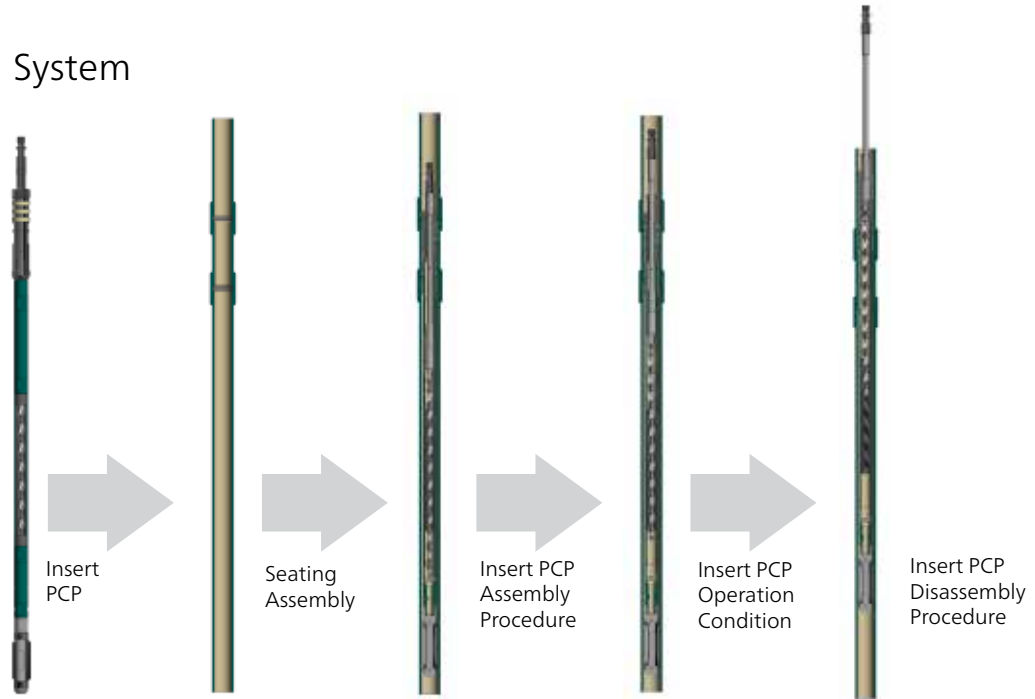

Nipple NETZSCH System

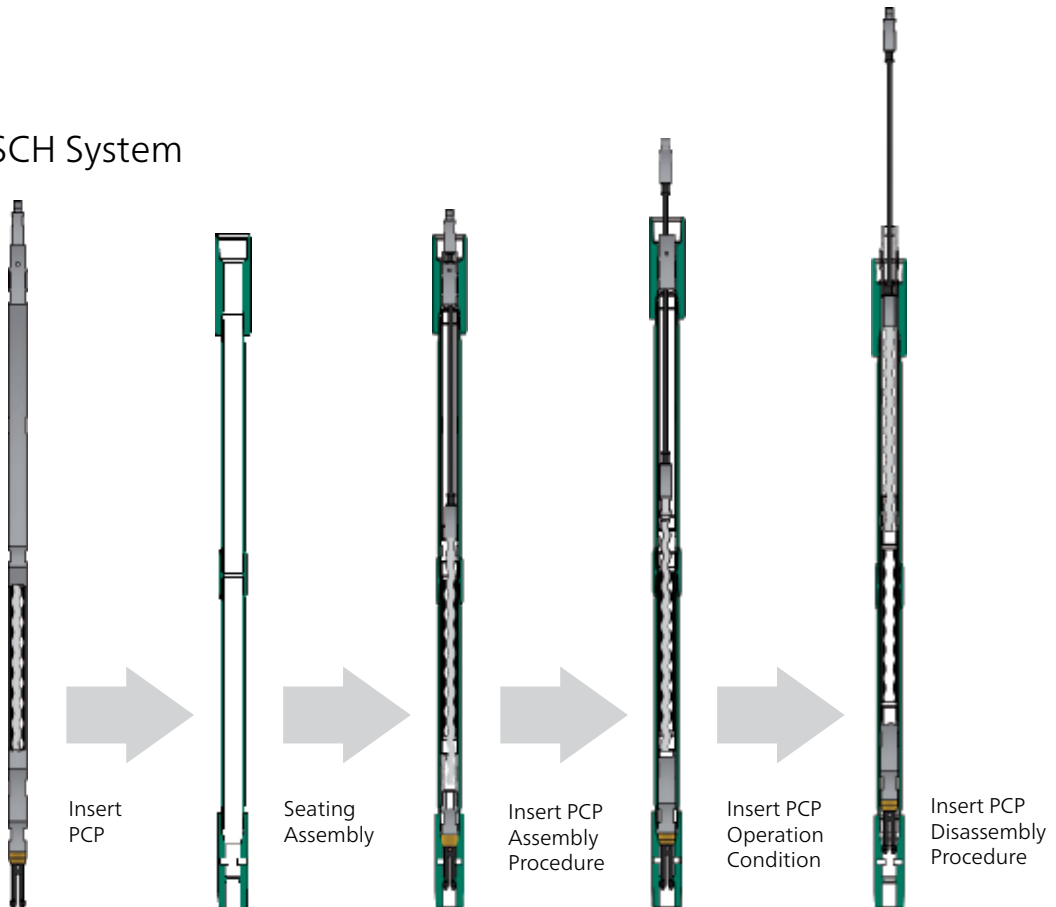

NTZ Elastomer Overview

CLASSIFICATION AND DESCRIPTION

FKM	459	Fluorocarbon rubber with outstanding resistance to crude oil (API gravity according to chart) and aromatic contents, good resistance to abrasion, CO ₂ and H ₂ S. Because of its characteristics, this elastomer is used to convey crude oil - water emulsions up to a fluid temperature of approximately 329°F / 165°C.
HNBR	332	Hydrogenated acrylonitrile butadiene rubber with medium to high acrylonitrile content (ACN), good resistance to crude oil (API gravity according to chart) and aromatic contents, outstanding abrasion resistance and good resistance to crude oil-water emulsions, CO ₂ and H ₂ S. Owing to its characteristics, this elastomer is used to convey crude oil - water emulsions up to a fluid temperature of about 302°F / 150°C.
	320	Hydrogenated acrylonitrile butadiene rubber with medium to high acrylonitrile content (ACN), medium to good resistance to crude oil (API gravity according to chart) and aromatic contents, outstanding abrasion resistance and medium to good resistance to crude oil - water emulsions, CO ₂ and H ₂ S. As a result of its characteristics, this elastomer is used to convey crude oil-water emulsions up to a fluid temperature of about 248°F / 120°C.
NBR	299	Acrylonitrile butadiene rubber with high acrylonitrile content (ACN), outstanding resistance to crude oil (API gravity according to chart) and aromatic contents, high abrasion resistance and good resistance to crude oil - water emulsions, CO ₂ and H ₂ S. Due to its characteristics, this elastomer is used to convey crude oil up to a fluid temperature of 248°F / 120°C.
	286	Acrylonitrile butadiene rubber with high acrylonitrile content (ACN), outstanding resistance to crude oil (API gravity according to chart) and aromatic contents, high abrasion resistance and good resistance to crude oil - water emulsions, CO ₂ and H ₂ S. Because of its characteristics, this elastomer is used to convey crude oil - water emulsions up to a fluid temperature of approximately 194°F / 90°C.
	261	Acrylonitrile butadiene rubber with high acrylonitrile content (ACN), outstanding resistance to crude oil (API gravity according to chart) and aromatic contents, high abrasion resistance, low coefficient of friction and good resistance to crude oil - water emulsions, CO ₂ and H ₂ S. Owing to its characteristics, this elastomer is used to convey crude oil - water emulsions up to a fluid temperature of approximately 212°F / 100°C.
	237	Acrylonitrile butadiene rubber with medium acrylonitrile content (ACN), good resistance to water and high-viscosity oil (API gravity according to chart) and high abrasion resistance. As a result of its characteristics, this elastomer is used to convey crude oil - water emulsions up to a fluid temperature of approximately 185°F / 85°C.

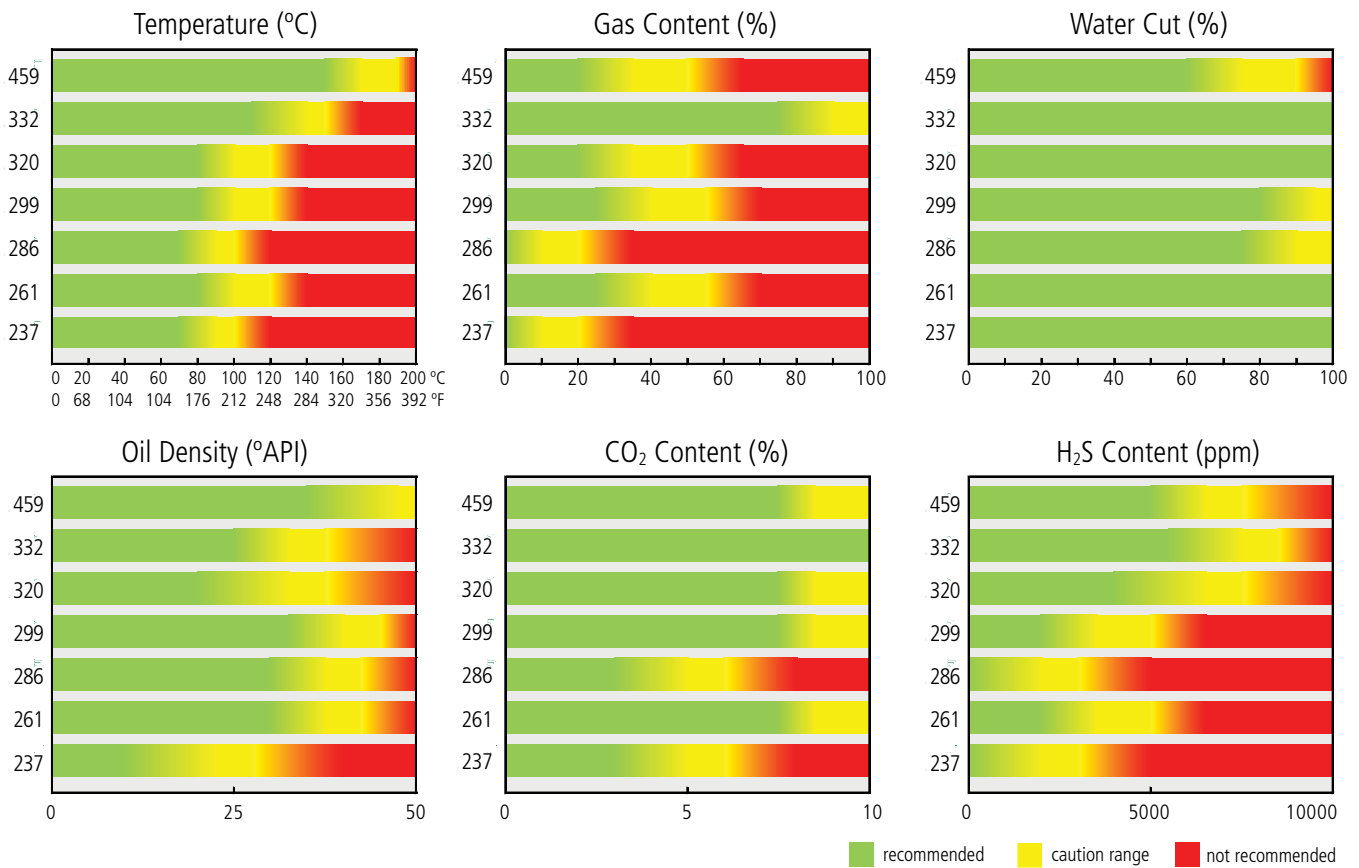

Please take into consideration that the given material limits are a guideline. The final selection has to be based on a detailed analysis (e.g. swelling test).

NETZSCH Pump NTM Model

Metal-to-Metal Downhole Pumps for High Temperature In-Situ Applications

Key Advantages

- Wide temperature range up to 660°F / 350°C.
- Wide range of viscosities.
- Reduced pump length due to greater pressure capability per stage.
- Easier handling.
- Designed specifically for steam-assisted gravity drainage (SAGD) and for cyclic steam simulation (CSS) recovery methods.
- Tight metal-to-metal rotor/stator tolerances for optimal performance.
- Elastomer-free pump guarantees no chemical attack swelling or hysteresis worries.
- Max head 2,200 psi / 150 bar.

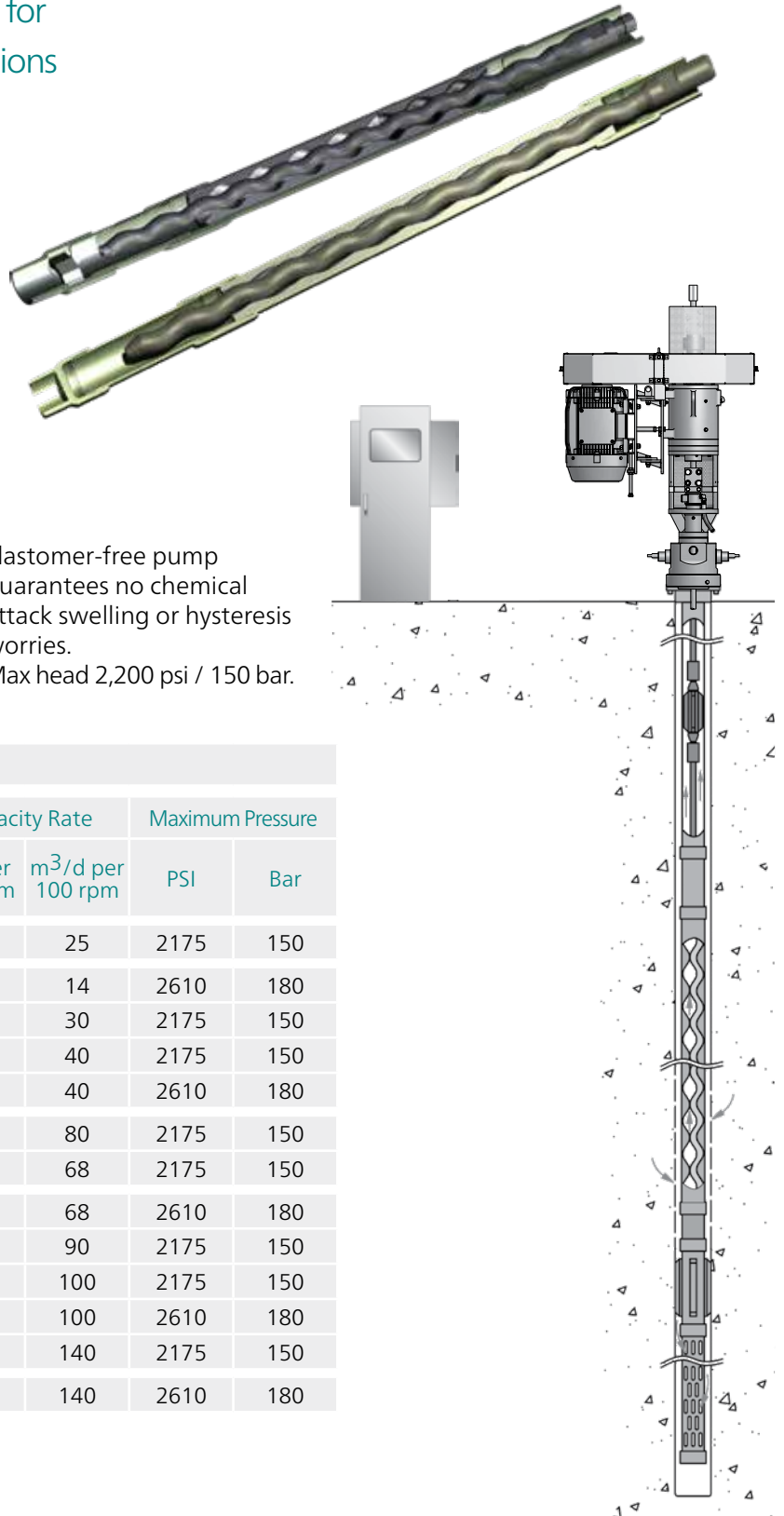

PCP Metal-to-Metal

Pump Model		Capacity Rate		Maximum Pressure	
NETZSCH Model	Imperial	b/d per 100 rpm	m ³ /d per 100 rpm	PSI	Bar
NTZ 278*150STM25	2175-S-157	157	25	2175	150
NTZ 350*180STM14	2510-S-88	88	14	2610	180
NTZ 350*150STM30	2175-S-189	189	30	2175	150
NTZ 350*150STM40	2175-S-252	252	40	2175	150
NTZ 350*180STM40	2610-S-252	252	40	2610	180
NTZ 350*150STM80	2175-S-503	503	80	2175	150
NTZ 450*150STM68	2175-S-428	428	68	2175	150
NTZ 450*180STM68	2610-S-428	428	68	2610	180
NTZ 450*150STM90	2175-S-566	566	90	2175	150
NTZ 550*150STM100	2175-S-629	629	100	2175	150
NTZ 550*180STM100	2610-S-629	629	100	2610	180
NTZ 550*150STM140	2175-S-881	881	140	2175	150
NTZ 550*180STM140	2610-S-881	881	140	2610	180

Drive Head Equipment

NETZSCH Drive Head Functions

Drive heads transfer the drive power to the pump through a rod string which provides the seal of the fluid between the well and polished rod. The drive head also supports the weight of the rod string and the axial load associated, determined by the pumping action from a downhole pump. It controls the backspin by different variants of the brake system as well.

Key Advantages

- NETZSCH Drive Heads are connected directly to the well head, eliminating the need for a concrete base.
- The space required for installation on the well is much smaller than many other artificial lift systems.
- The API flange allows a direct connection without adapters when changing other systems to the NETZSCH PC Pump System.
- The simple design minimizes maintenance and requires little lubrication.
- The bearing system provides minimal vibration.
- Easily adjusts to production rates or changing rotations by mechanical process or with speed controllers (or with a simple change of acceleration if using internal combustion motors).



NDH AAA BC X DD EE

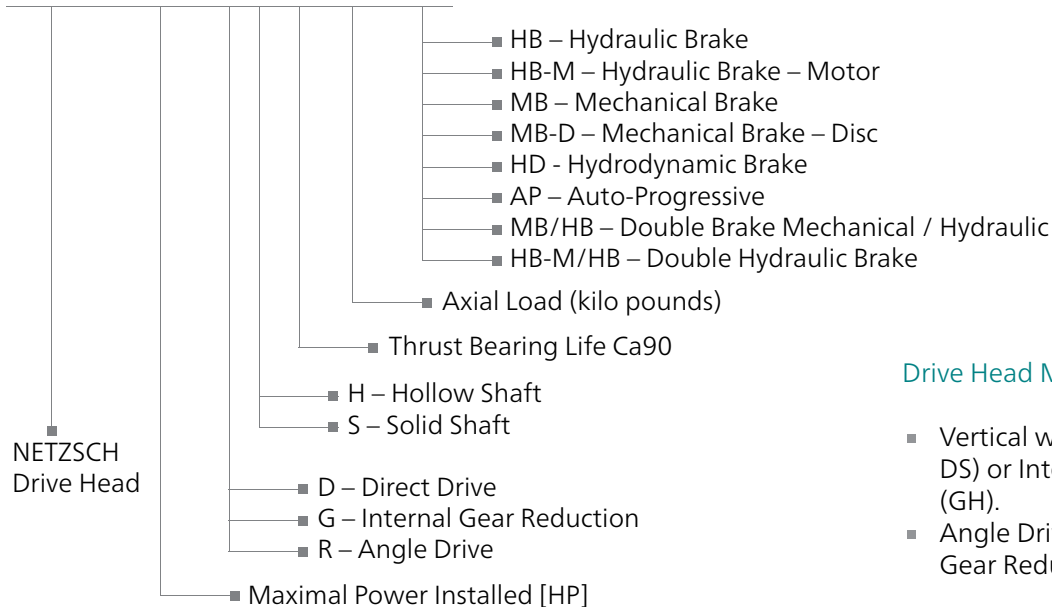

Drive Head Models

- Vertical with Direct Drive (DH, DS) or Internal Gear Reduction (GH).
- Angle Drive (RH) with Internal Gear Reduction.

Vertical Drive Head

DIRECT DRIVE DH – Hollow Shaft

Features

- No gears.
- Economical and reliable.
- Used where higher rotations are expected for the application.
- Rotations are reached by changing the set of pulleys and/or through a variable frequency drive (VSD).

Specifications

- Power: 5 to 200 HP.
- Axial Load: 5 to 93 klb.
- Speed range: 130 to 500 rpm.
- Maximum Torque: 3,500 ft-lb / 4,800 Nm.
- Brake Systems: Single or Double
- Transmission: Pulleys and belts.



- Sealing system: Stuffing Box or Mechanical Seal.
- Tee Flow Connection: Flange API Spec. 6A Type 6B/Thread API 5B.

Double Motor - High Powers

- Specifically designed for deep well applications.
- The Rod String is driven by two separate motors.
- Transmission by belts and pulleys.
- Due to high torque from the backspin, a double brake can be installed.



Vertical Drive Head Model	Maximum Power (HP)	Axial Load		Maximum Torque [Nm]	Speed Range (1) [rpm]	Brake Types						Polished Rod				
		klb	kN			MB	MB-D	HB	HB-M	HD	AP	1-1/8"	1-1/4"	1-1/2"	1.9"	
NDH 005 DH 5	5	5	23	500	130~500	x							x			
NDH 010 DH 5	10	5	23	500	130~500	x							x			
NDH 010 DH 9	10	9	40	500	130~500	x					x			x		
NDH 020 DH 9	20	9	40	1500	130~500	x								x		
NDH 020 DH 20	20	20	90	1500	130~500			x		x				x		
NDH 030 DH 9	30	9	40	1500	130~500	x		x		x				x	x	
NDH 040 DH 9	40	9	40	2000	150~500			x		x				x	x	
NDH 040 DH 20	40	20	90	2000	150~500			x	x	x	x			x	x	
NDH 040 DH 33	40	33	150	2000	150~500		x	x	x	x				x	x	x
NDH 060 DH 20	60	20	90	2000	190~500		x	x	x	x				x	x	x
NDH 060 DH 33	60	33	150	2000	190~500		x	x	x	x				x	x	x
NDH 075 DH 33	75	33	150	2000	190~500		x	x		x					x	x
NDH 075 DH 37	75	37	170	2000	190~500		x								x	x
NDH 100 DH 33	100	33	150	3400	220~500		x								x	x
NDH 100 DH X 50	100	50	230	3400	220~500		x								x	x
NDH 125 DH X 58	125	58	263	3400	220~500		x								x	x
NDH 150 DH X 50	2x75	50	263	2500	190~500		x								x	x
NDH 200 DH X 58	2x100	58	263	4800	220~500		x								x	x
NDH 200 DH x 80	2x100	80	363	4800	220~500		x								x	x
NDH 100 DH X 93	2x100	93	422	4100	220~500		x								x	x

(1) Speed Range for motor 60 HZ - 6 poles

Vertical Drive Head Vertical

INTEGRATED GEAR BOX GH – HOLLOW SHAFT

APPLICATION WITH PERMANENT MAGNETIC MOTOR (PMM)

Features

- Vertical Drive Head is especially used for low speed application particularly for PC Pumps with high flow.
- The integrated reduction allows a rotation reduction ratio of 1:4.76.
- Speeds are reached using an variable frequency drive (VSD).
- Can be used with Hydraulic Motor.



Specifications

- Power: 20 to 75 hp.
- Axial Load: 9 to 33 klb.
- Speed Range: 80 to 400 rpm.
- Brake System: Single.
- Transmission: Gear Box.
- Sealing System: Stuffing Box or Mechanical Seal/Lip Seal.
- Tee Flow Connection: Flange API Spec. 6A Type 6B.

Solid Shaft Drive Head Model	Maximum Power (HP)	Axial Load		Maximum Torque [Nm]	Speed Range (1) [rpm]	Brake Types						Sucker Rod	
		klb	kN			MB	MB-D	HB	HB-M	HD	AP	1"(2)	1-1/8" (2)
NDH 020 DS 20	20	20	90	1500	80~500	x						x	
NDH 060 DS 20	60	20	90	2000	80~500	x							x
NDH 060 DS 33	60	33	150	2000	80~500	x							x
NDH 075 DS 33	75	33	150	2000	80~500	x							x
NDH 075 DS 37	75	37	170	2000	80~500	x							x
NDH 075 DS 50	75	50	230	2000	80~500	x		x	x				x
NDH 100 DS 37	100	37	170	3400	80~500	x							x
NDH 100 DS 50	100	50	230	3400	80~500	x							x

Angle Drive Head

ANGLE DRIVE WITH GEAR BOX RH – HOLLOW SHAFT

Features

- Angle Drive Head is especially used for low speed applications particularly for PC Pumps with high flow.
- The integrated reduction allows a rotation reduction ratio of 1:4.
- The geometry of the Angle Drive Head allows the alternative use of a combustion motor or hydraulic motor.
- If the motor with combustion is used, the expected speed is achieved by a change in acceleration.
- Application available without pulleys and belts.

Specifications

- Power: 20 to 60 hp.
- Axial Load: 9 to 33 klb.
- Speed Range: 50 to 300 rpm.
- Brake System: Single or Double.
- Transmission: Gear Box coupled.
- Sealing System: Stuffing Box or Mechanical Seal/Lip Seal.
- Tee Flow Connection: Flange API Spec. 6A Type 6B/Thread API 5B.

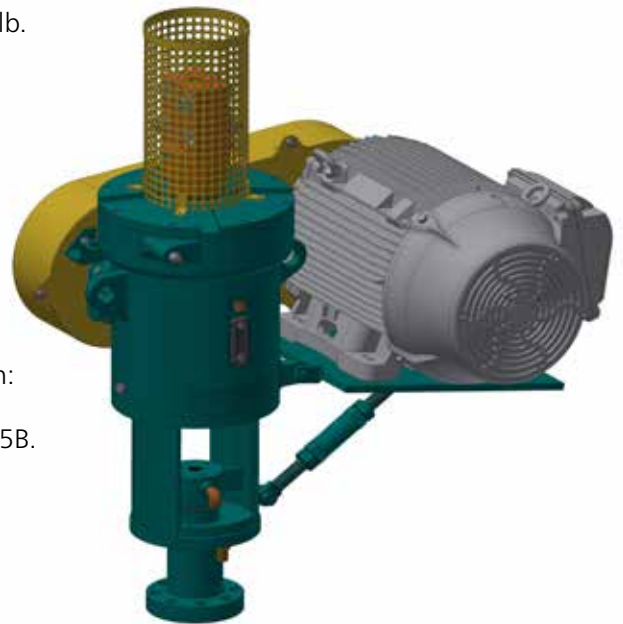

NETZSCH Angle Drive Head – Angle Drive with Gear Box RH – Hollow Shaft

Drive Head Models	Maximum Power (HP)	Axial Load		Speed Range (1) [rpm]	Brake Types				Polished Rod	
		klb	kN		MB	HB/HD	HB-M	AP	1-1/4"	1-1/2"
NDH020RH9	20	9	40	80-400	X	X			X	
NDH020RH20	20	20	90	80-400	X	X			X	
NDH040RH20	40	20	90	80-400	X	X		X		X
NDH040RH33	40	33	150	80-400	X	X		X		X
NDH060RH20	60	20	90	100-400	X		X	X		X
NDH060RH33	60	33	150	100-400	X		X	X		X

(1) Speed Range for motor 60 HZ – 6 poles

Brake Systems

Mechanical Brake - MB

- Based on the mechanical friction between the speed and stationary parts, the brake is activated by compressing the surface.
- The brake system backspin operating with free wheels.
- The Drive Head shaft turns freely in a clockwise direction, but hangs on opposite direction.
- To release the energy accumulated in the rod string and relieve the brake, the frictional force "F" must be released gradually.

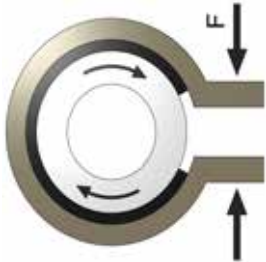

Mechanical Brake Disc - MB-D

This mechanical backspin brake operates by means of a built-in disc brake. In case the drive head shaft experiences opposite rotation due to backspin, a small hydraulic pump—driven by the drive shaft speed—generates hydraulic pressure which activates the disc brake. The disc brake restricts or avoids the driven shaft from speed, depending on the braking torque caused by the hydraulic pressure on the brake piston. A mechanism of the control unit releases the disc brake continuously to avoid the overheating of brake pads and disc. In normal operation, the hydraulic pump works only as a circulating pump without generating pressure.

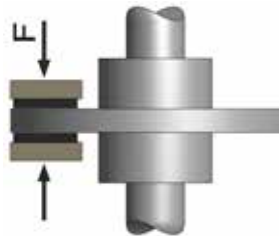

Hydraulic Brake/Hydrodynamic HB - HD

The hydraulic brake system works through a built-in vane pump, but without discharge connection. The oil in the system is forced to go through all the internal spaces of the brake system preventing the automatic acceleration of the speed (backspin). The braking system is directly coupled to a free wheel and the Drive Head shaft. In order to turn while operating (working conditions), the brake system remains stationary (static) and it is activated only during the reverse speed.

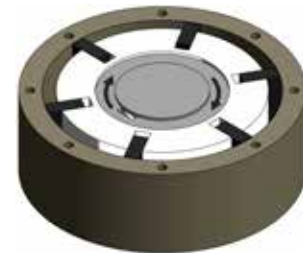

Auto Progressive - AP

- Operates independently without needing to be controlled.
- Due to its hydrodynamic characteristics, the braking effect occurs in one direction.
- The damage caused by over speed the drive buffer is reliably avoided.



Brake HB-M

- The HB-M system operates by a hydraulic motor, attached to a free wheel to the drive shaft.
- In case of backspin, the free wheel is locked by means of the hydraulic motor.
- The motor pumps oil through a valve, regulating the back pressure and the backspin speed.



Double Brake

- Drive Heads with two brake systems, applied where high torque is required and for deep wells.
- Combinations can be hydraulic and mechanical or double hydraulic.

Pump Equipment – Torque Anchors

Torque Anchor

NT Model

Torque anchors are used to absorb the reactive torque, created by the friction between the rotor and the stator of the helicoidal pump with progressing cavities, to prevent the tubing from unscrewing. The torque anchor is mounted under the pump.

The blades continuously maintain contact with the well casing wall by means of helicoidal springs. The fluid pumped is passing through the central hollow shaft onto which the cams are mounted.

When the tubing rotates clockwise, the anchoring blades bite into the casing wall whenever a reactive torque is developed. Disengaging is done by rotating the tubing counter-clockwise from the surface.

Torque anchors are available for different casing sizes and with several tubing connection threads. The common ones are listed below. Make sure that the working range of the torque anchor is suitable for the internal diameter of the casing you are using.

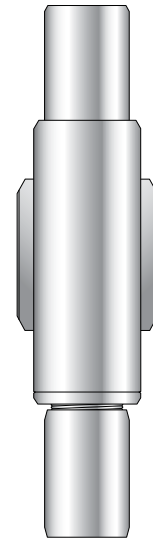

Currently available in the US and EMEA markets

Torque Anchor (Type single)

Casing OD		Connection inch	Internal Diameter		Working Range		Product Number
inch	mm		inch	mm	inch	mm	
5-1/2"	139.7	2-7/8" EU	2.5	63.5	4.67~5.04	118.6 ~ 128.1	NDB4995007
5-3/4"	146.1	2-7/8" EU	2.5	63.5	4.99~5.29	126.8 ~ 134.4	NDB4995146
5-3/4"	146.1	3-1/2" EU	2.5	63.5	4.99~5.29	126.8 ~ 134.4	NDB4995196
6-5/8"	168.3	2-7/8" EU	3	76.2	5.68~6.14	144.2 ~ 155.8	NDB4995147
7"	177.8	2-7/8" EU	2.5	63.5	6.09~6.54	154.8 ~ 166.1	NDB4995123
7"	177.8	3-1/2" EU	3	76.2	6.09~6.54	154.8 ~ 166.1	NDB4995008
7"	177.8	4-1/2" EU	3	76.2	6.09~6.54	154.8 ~ 166.1	NDB4995289
8-5/8"	219.1	3-1/2" EU	3	76.2	7.51~8.1	190.8 ~ 205.7	NDB4995265
9-5/8"	244.5	3-1/2" EU	3	76.2	8.54~9.06	216.8 ~ 230.2	NDB4995059
9-5/8"	244.5	4-1/2" EU	4	101.6	8.54~9.06	216.8 ~ 230.2	NDB4995165

Torque Anchor

RT Model

The RT Model torque anchor is designed with six teeth which centralize and anchor the PC pump in a stable position even with strong vibrations. The ramp design of the teeth ensures a firm settling within the whole working range as well as easy loosening when they

need to be uninstalled. A larger contact area of the teeth reduces the contact pressure between the teeth and internal tube diameter which minimizes the risk of tube deformation or damage. Holes above the teeth ensure the fluid communication with the annulus.



Patent pending

Torque Anchor (Type single)

Casing OD		Connection inch	Internal Diameter		Working Range		Product Number
inch	mm		inch	mm	inch	mm	
5.5"	139.7	2-7/8" EU	2.5	63.5	4.67~5.04	118.6 ~ 128.1	NDB4995310
6-5/8"	168.3	1-1/2" EU	3	76.2	5.68~6.14	144.2 ~ 155.8	NDB4995147
7"	177.8	3-1/2" EU	3	76.2	6.09~6.54	154.8 ~ 166.1	NDB4995357

Well Head Equipment

Composite Blow Out Preventor

BOP with Integrated Flow Tee

With the Composite BOP, NETZSCH offers higher safety and efficiency for the oil well Connection System.



Technical Information

- Lower well completion investment.
- Higher connection flexibility.
- Prevents blow-out of the system.
- Reduces installation height of the drive head.
- Provides blow-out protection of production piping (Pipeline) in case of maintenance or failure.
- Ensures operational safety during maintenance of the polished rod's sealing system, avoiding blow-out during intervention.
- More rigid and compact installation, reduction of localized tensions ensuring higher mechanical resistance of the assembly and better vibration absorption.
- Flanged and threaded connections according to API norms.
- Sealing test connection.
- Shaft BOP installation connection.

Blow Out Preventor with Integrated Flow Tee

BF Lower Connection	UF Upper Connection	PL Thread	AL Thread	D Polished Shaft	ID		G	H		API Thread R	Optional				Approx. Wt.	
					in	mm		in	mm		Tubing Hanger Fitting				lbs	kg
											B (in)	B (mm)	L (in)	L (mm)		
2-9/16"-5000 psi	3-1/8"-2000 psi	2" LP	1/2" NPT	7/8"	2.59	66	3" LP	12.00	305	2-7/8"	-	-	-	-	375	170
7-1/16"-3000 psi			1" NPT	1"	3.11	79				3-1/2"	5.381	136.7	3" LP	-	419	190
7-1/16"-5000 psi	1" LP	1-1/8"	4"	5.381				136.7	1.315	34.4	551	250				
11"-3000 psi	4-1/16"-3000 psi	4" LP	1" LP	1-1/4"	4.25	108	4-1/2" EU	19.29	490	4-1/2"	5.499	139.7	2.755	70	639	290
			1-1/2"	5"						5.999	152.4	5.117	130			
11"-5000 psi			2" LP	1-1/2"				21.26	540	5-1/2"	6.062	154	4.212	107	970	440

Technical Data and Assembly Dimensions

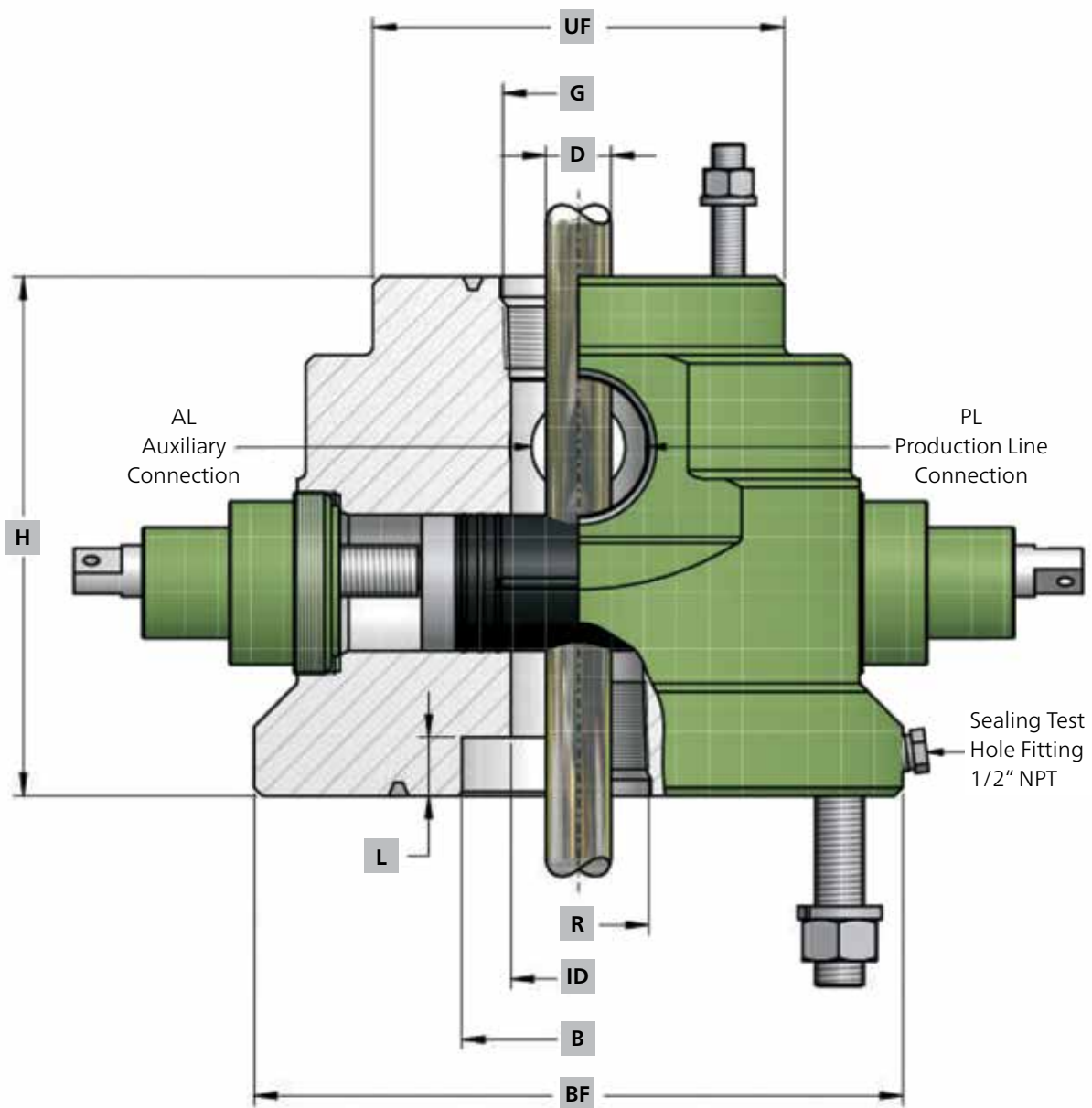

NETZSCH reserves the right to modify this information without previous notice.

Applications Process Flow Chart in Oil Field

From Upstream through Midstream and Downstream Application, the wide product range of NETZSCH Pumps and Systems for the Oil & Gas Industry provides the optimum solution for you.

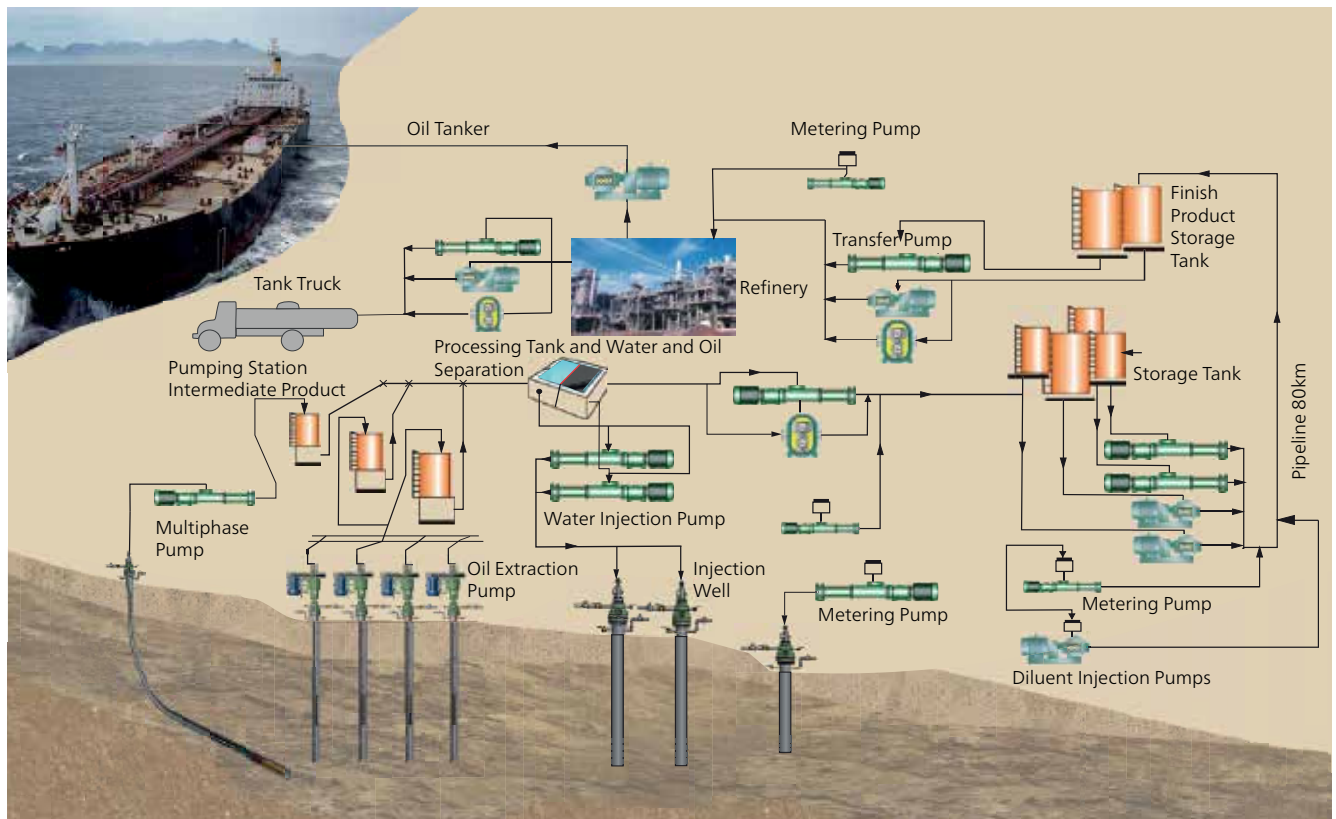

 NEMO® Progressing Cavity Pumps

 NEMO® Progressing Cavity Pumps, lubricant

 TORNADO® Rotary Lobe Pumps

 Submersible Driven Downhole PC Pumps

 Top Driven Downhole PC Pumps

 NOTOS® Multi Screw Pump

Applications

The Transfer Pump



We offer both high-pressure and low pressure pumps for conveying crude oil to its destination. Heated versions of our pumps are also available, if necessary, allowing you round-the-clock operation even at sub-freezing temperatures.

NEMO® high flow transfer pump:

- Up to 500 m³/h (60,000 bpd) maximum flow capacity.
- Up to 24 bar (350 psi) maximum differential pressure.

NEMO® high pressure transfer pump:

- Up to 120 m³/h (18,000 bpd) maximum flow capacity.
- Up to 72 bar (1,050 psi) maximum differential pressure.

Applications

The Multiphase Pump

The multiphase pump was specially developed for conveying oil gas/water mixtures. This pump provides dependable operation even at gas

proportions up to 90 %, in special execution up to 100 %. Capacities up to 500 m³/h (60,000 bpd), and pressure up to 24 bar (350 psi).



The Water-Injection-Pump

Crude oil must often be pressed out of the rock. This necessitates the use of pumps which are capable of maintaining high conveying pressure at the best degrees of efficiency.

Up to 500 m³/d (3,100 bpd) maximum flow capacity.
Up to 240 bar (3,500 psi) maximum differential pressure.

Contact

For these applications we will arrange for a specialist from Mid- and Downstream NETZSCH companies to contact you.

Questionnaire for Oil & Gas Upstream

Contact

company		address	
name		phone	
telefax		e-mail	

Well Completion Data

well no.		field name	
vertical depth*	<input type="checkbox"/> [m] <input type="checkbox"/> [ft]	perforation depth	from <input type="checkbox"/> [m] <input type="checkbox"/> [ft] to <input type="checkbox"/> [m] <input type="checkbox"/> [ft]
well information	<input type="checkbox"/> vertical <input type="checkbox"/> deviated ¹ <input type="checkbox"/> horizontal ¹	<input type="checkbox"/> existing <input type="checkbox"/> newly drilled <input type="checkbox"/> planned	
well head information	<input type="checkbox"/> 3 1/8" x 2000 psi <input type="checkbox"/> 3 1/8" x 3000 psi <input type="checkbox"/> other ³		
electrical power	[Volts]	[Hz]	ambient temperature <input type="checkbox"/> [°C] <input type="checkbox"/> [°F]
casing ²		tubing ²	sucker rod
size	<input type="checkbox"/> [inch] <input type="checkbox"/> [mm]	size <input type="checkbox"/> [inch] <input type="checkbox"/> [mm]	size <input type="checkbox"/> [inch] <input type="checkbox"/> [mm]
inside dia	<input type="checkbox"/> [inch] <input type="checkbox"/> [mm]	inside dia <input type="checkbox"/> [inch] <input type="checkbox"/> [mm]	material <input type="checkbox"/> grade D <input type="checkbox"/> grade K <input type="checkbox"/> special
weight	[lbs]	weight [lbs] thread <input type="checkbox"/> EU <input type="checkbox"/> NU	

Production Data

current lift method			
production rate	current <input type="checkbox"/> [bpd] <input type="checkbox"/> [m ³ /d]	planned <input type="checkbox"/> [bpd] <input type="checkbox"/> [m ³ /d]	water cut [%]
pump setting depth*	current <input type="checkbox"/> [m] <input type="checkbox"/> [ft]	planned <input type="checkbox"/> [m] <input type="checkbox"/> [ft]	sand cut [%]
dynamic fluid level*	current <input type="checkbox"/> [m] <input type="checkbox"/> [ft]	planned <input type="checkbox"/> [m] <input type="checkbox"/> [ft]	static fluid level* <input type="checkbox"/> [m] <input type="checkbox"/> [ft]
static BHP (at perf.)	<input type="checkbox"/> [bar] <input type="checkbox"/> [psi]	productivity index	<input type="checkbox"/> [b/d/psi] <input type="checkbox"/> [m ³ /d/psi]
dynamic BHP (at perf.)	<input type="checkbox"/> [bar] <input type="checkbox"/> [psi]	casing pressure	<input type="checkbox"/> [bar] <input type="checkbox"/> [psi]
GOR	<input type="checkbox"/> [m ³ /m ³] <input type="checkbox"/> [cuft/bbl]	flow line pressure	<input type="checkbox"/> [bar] <input type="checkbox"/> [psi]

Fluid Data

chemical treatment	<input type="checkbox"/> yes <input type="checkbox"/> no	bubble point pressure	<input type="checkbox"/> [bar] <input type="checkbox"/> [psi]
paraffin production	<input type="checkbox"/> yes <input type="checkbox"/> no	CO ₂ content	<input type="checkbox"/> [%] <input type="checkbox"/> [ppm]
oil viscosity at surface	[cP]	H ₂ S content	<input type="checkbox"/> [%] <input type="checkbox"/> [ppm]
oil viscosity at pump	[cP]	aromatics ⁴	[%]
chloride content	[%]	specific oil density ⁴	<input type="checkbox"/> [bar] <input type="checkbox"/> [psi]
temperature at surface	<input type="checkbox"/> [°C] <input type="checkbox"/> [°F]	temperature at pump	<input type="checkbox"/> [°C] <input type="checkbox"/> [°F]

Attachments and Comments

<input type="checkbox"/> ¹ well bore geometry	<input type="checkbox"/> ² completion details	<input type="checkbox"/> ³ wellhead drawing	<input type="checkbox"/> ⁴ fluid analysis	<input type="checkbox"/> other	*from surface

Please complete as accurately as possible!

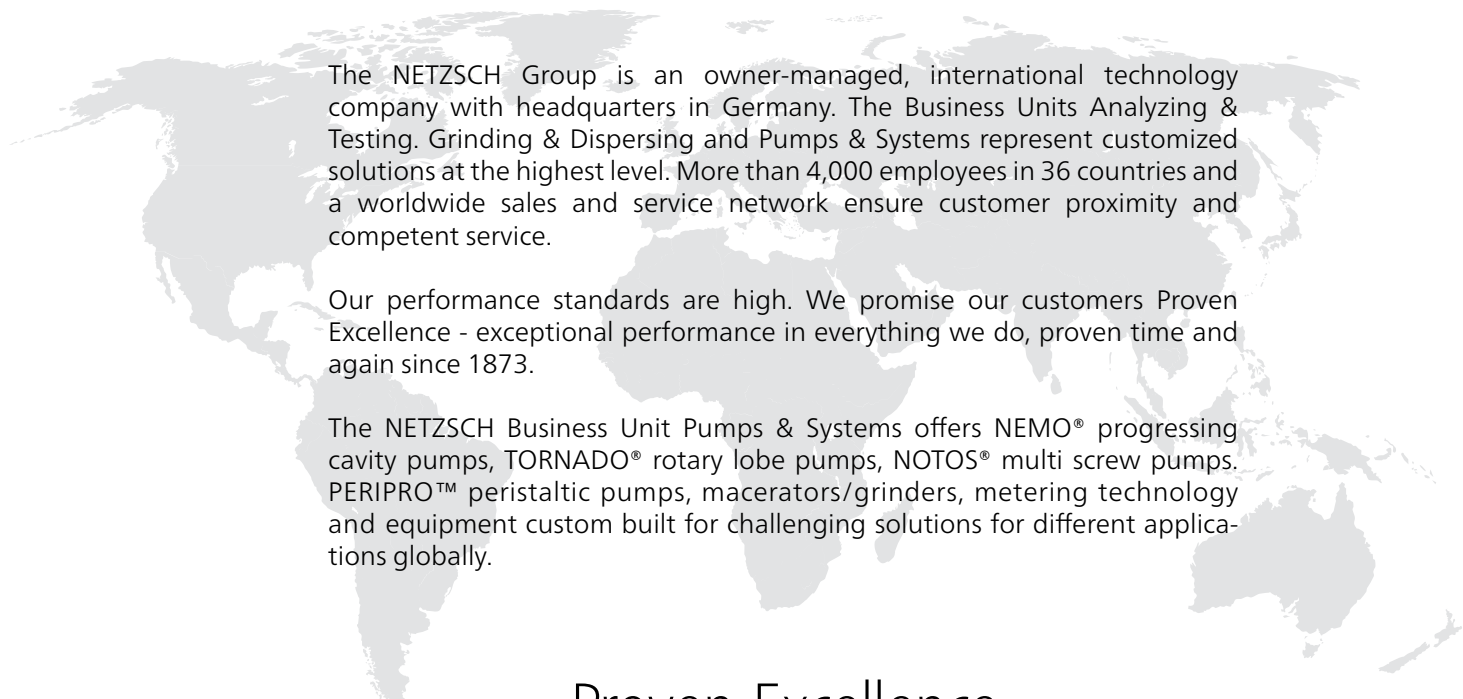

The NETZSCH Group is an owner-managed, international technology company with headquarters in Germany. The Business Units Analyzing & Testing, Grinding & Dispersing and Pumps & Systems represent customized solutions at the highest level. More than 4,000 employees in 36 countries and a worldwide sales and service network ensure customer proximity and competent service.

Our performance standards are high. We promise our customers Proven Excellence - exceptional performance in everything we do, proven time and again since 1873.

The NETZSCH Business Unit Pumps & Systems offers NEMO® progressing cavity pumps, TORNADO® rotary lobe pumps, NOTOS® multi screw pumps, PERIPRO™ peristaltic pumps, macerators/grinders, metering technology and equipment custom built for challenging solutions for different applications globally.

Proven Excellence.

NETZSCH Pumpen
& Systeme GmbH
Geretsrieder Straße 1
84478 Waldkraiburg
Deutschland
Tel.: +49 8638 63-0
info.nps@netzsch.com

NETZSCH Asia Pacific Pte. Ltd.
Singapore
Tel.: +65 6863 4453
info.nap@netzsch.com

PT. NETZSCH Indonesia
Jakarta, Indonesia
Tel.: +62 21 296 75 385
info.nij@netzsch.com

NETZSCH Thailand Ltd.
Bangkok, Thailand
Tel.: +66 2 152 7325
info.ntb@netzsch.com

NETZSCH (Malaysia) Sdn Bhd
Shah Alam, Malaysia
Tel.: +60 3 5885 9201
info.nmk@netzsch.com

NETZSCH Vietnam Limited
Ho Chi Minh City, Vietnam
Tel.: +84 28 6281 1042
info.nvh@netzsch.com

NETZSCH Australia Pty Ltd
Head Office Brisbane
Tel.: +61 7 3488 8183
Regional Office Sydney
Tel.: +61 2 9641 2840
nas@netzsch.com

NETZSCH®

pumps-systems.netzsch.com